

# OPTICAL COMMUNICATION

## Unit I. INTRODUCTION TO OPTICAL FIBERS.

### Introduction:

A fiber optic cable is a light pipe that is used to carry light beams from one place to another. Communication medium is wire, free space or fiber optic cable.

### Advantages of fiber:

- \* wide bandwidth
- \* low transmission loss.
- \* light weight & small size
- \* Interference immunity & safety
- \* Electrical isolation.

### Disadvantages:

\* Small size & brittleness make more difficult to work with.

### General Optical fiber communication System:

Information source provides electrical signal to transmitter which drives optical source to give modulation of optical carrier.

Communication System - Transmitter, source, transmission medium, receiver.

Transmission medium - Optical fiber cable.

Optical source - LED/LASER.

optical detector - Photo diode.



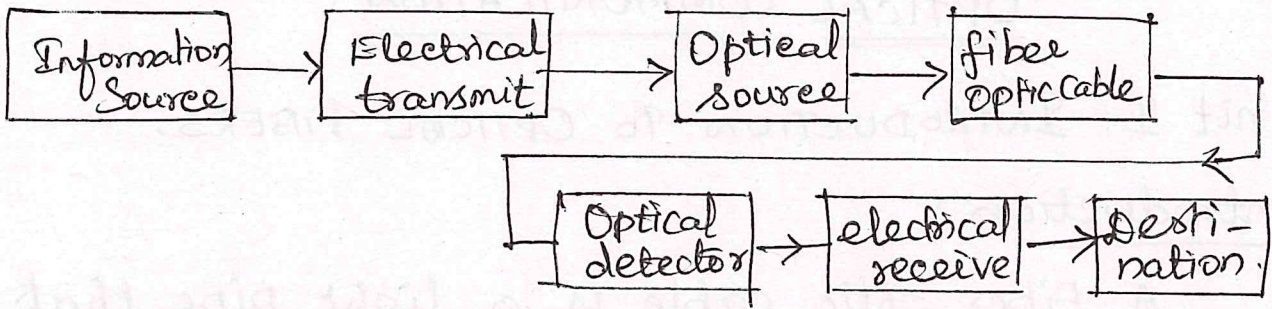

Source provides electro-optical conversion.  
 Detector performs optical-electrical conversion.

### Digital Optical System:

Digital signal is encoded, laser drive circuit modulates intensity of laser. Digital signal is launched into fiber. APD followed by amplifier & filter provide gain, noise reduction. Finally, it is decoded to get original information.

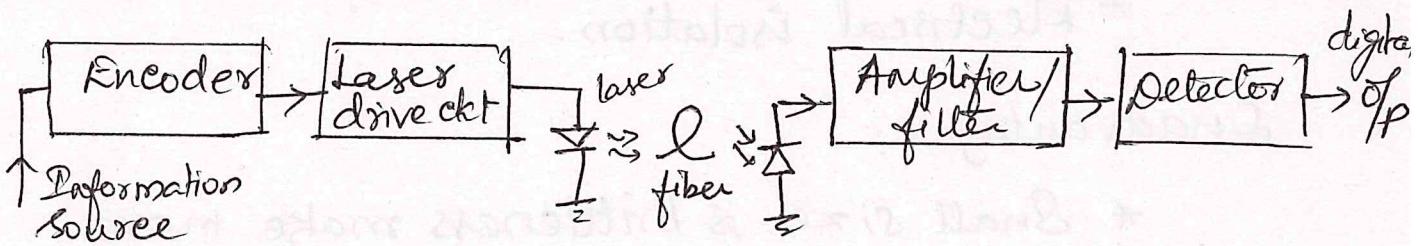

- Applications:
- \* Telecommunication
  - \* Cable TV N/w
  - \* Instrumentation
  - \* Data transmission.

### Basic Optical laws and Definitions:

\* Refractive Index =  $\frac{\text{Velocity of light in vacuum}}{\text{Velocity of light in medium}}$

\* Snell's law  $n_1 \sin \phi_1 = n_2 \sin \phi_2$

$\phi_1, \phi_2$  - Angle of incidence & refraction.

$n_1, n_2$  - Refractive indices of core & cladding.

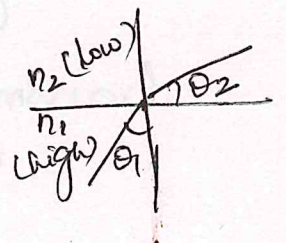



$$\sin \phi_c = n_2/n_1$$

At angles of incidence greater than critical angle, light is reflected back into originating dielectric medium (total internal reflection) with high efficiency.

Acceptance Angle:

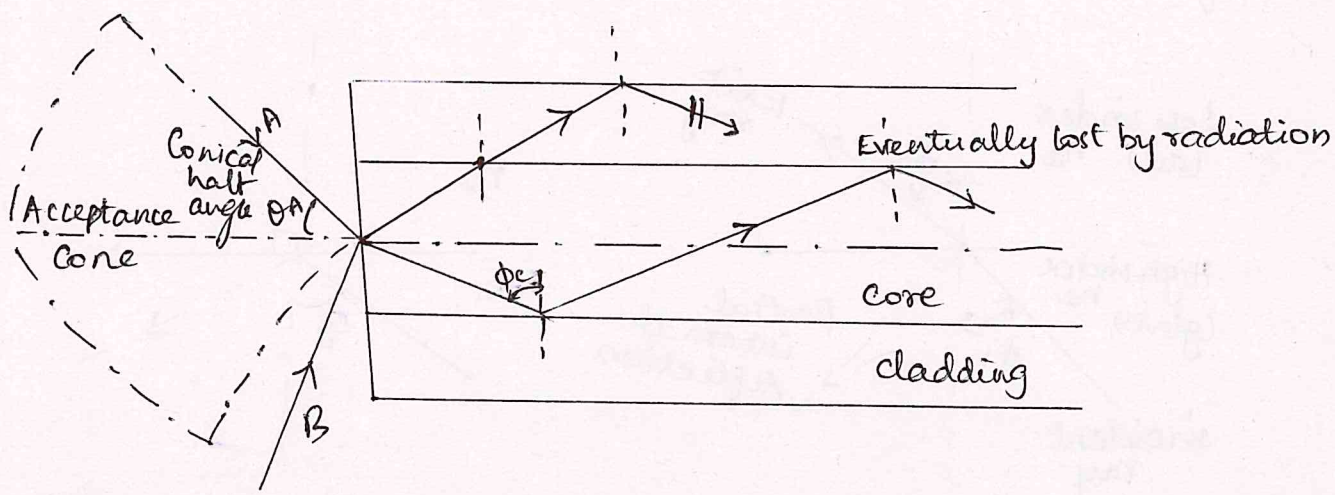

A meridional ray A at the critical  $\phi_c$  within the fiber at core-cladding interface. This ray centers the fiber core at angle  $\theta_a$  to fiber axis & is refracted at air-core interface before transmission to core-cladding interface at critical angle.

So, any rays incident into fiber core at an angle greater than  $\theta_a$  is transmitted to core-cladding interface at an angle less than  $\phi_c$  & will not be totally internally reflected. Thus for rays to be transmitted by total internal reflection within fiber core, must be incident on fiber core within acceptance cone defined by Conical half angle  $\theta_a$ .



A light ray travels more slowly in optically dense medium than in one that is less dense, and refractive index gives a measure of effect.

When a ray is incident on interface between two dielectrics of different refractive indices (glass-air) refraction occurs.

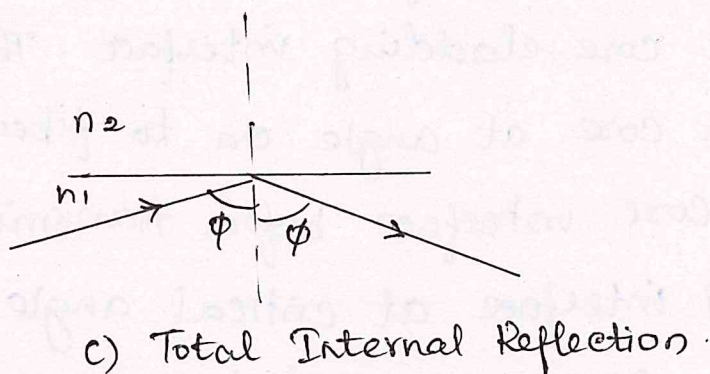
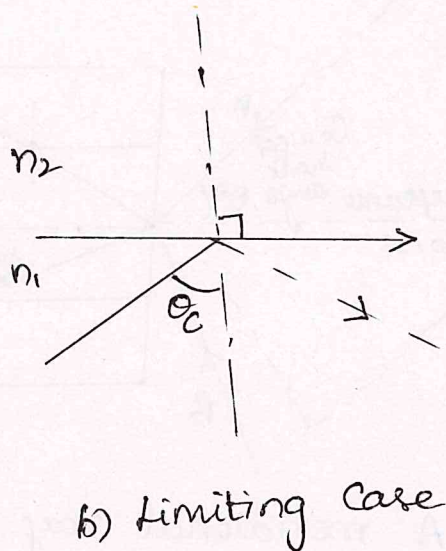
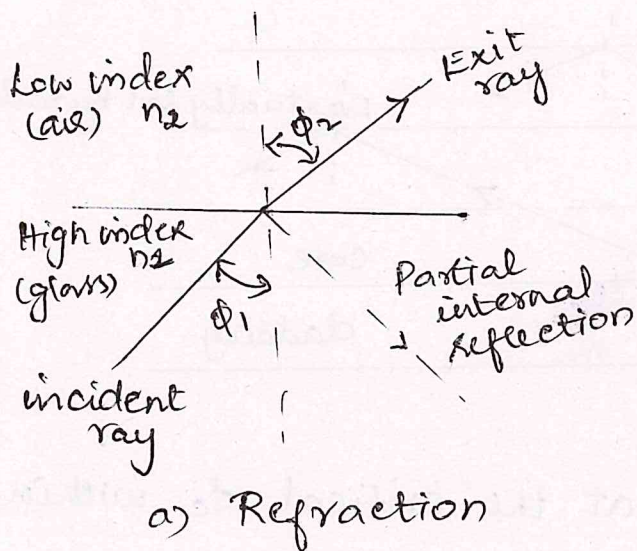

A small amount of light is reflected back into originating dielectric medium. As  $n_1 > n_2$ , angle of refraction is always greater than the angle of incidence. When angle of refraction is  $90^\circ$  & refracted ray emerges parallel to the interface between dielectrics angle of incidence  $< 90^\circ$ . This is limiting case of refraction & angle of incidence is critical angle  $\phi_c$ .



\* Critical Angle  $\phi_c \rightarrow$  Min. angle of incidence beyond which total internal reflection occurs.

$$\sin \phi_c = n_2/n_1$$

\* Total internal reflection  $\rightarrow$  Angle of incidence  $\theta_1$  in dense material becomes smaller, reflected angle  $\theta_2$  approaches zero. Beyond this, no refraction, rays become totally internally reflected.

\* Acceptance angle  $\theta_a \rightarrow$  Max. angle to the axis at which light ray enters the fiber to be propagated.

\* Meridional ray  $\rightarrow$  light ray passed thro' axis of fiber

\* Skew rays  $\rightarrow$  follow helical path, not thro' axis.

\* Numerical Aperture (NA)  $\rightarrow$  Light collecting ability of fiber.

Relationship between  $\theta_a, n_1, n_2$ :

By Snell's law,

$$\begin{aligned} n_0 \sin \theta_1 &= n_1 \sin \theta_2 \\ &= n_1 \cos \phi \\ &= n_1 (1 - \sin^2 \phi)^{1/2} \end{aligned}$$

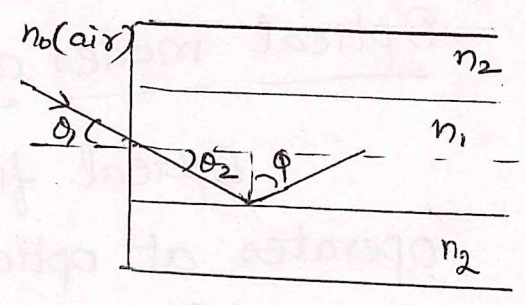

If  $\theta_1$  becomes  $\theta_a$ ,  $\phi = \phi_c$ , then

$$NA = n_0 \sin \theta_a = (n_1^2 - n_2^2)^{1/2}$$

Refractive index difference between core + cladding

$$\Delta = \frac{n_1^2 - n_2^2}{2n_1^2} \approx \frac{n_1 - n_2}{n_1} \text{ for } \Delta \ll 1$$

$$\therefore NA = n_1 (2\Delta)^{1/2}$$



## Skew rays:

- These rays are not transmitted thro' fiber axis.
- follow a helical path.
- difficult to travel as they travel along fiber.
- don't lie in single plane.

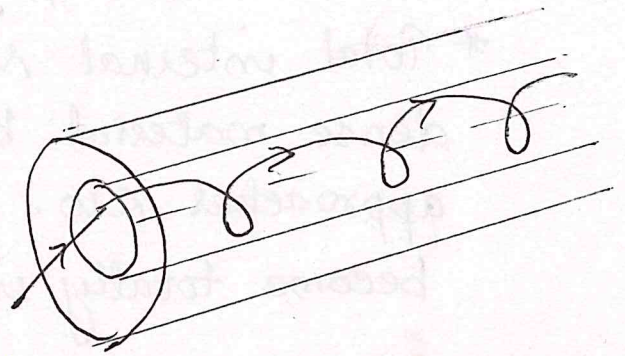

If  $\gamma$  is angle of between projection of ray in two dimensions and radius of fiber core at point of reflection.

Acceptance conditions for skew rays are

$$n_0 \sin \theta_{as} \cos \gamma = (n_1^2 - n_2^2)^{1/2} = NA$$

If fiber in air ( $n_0 = 1$ ), then  $NA = \sin \theta_{as} \cos \gamma$

$$\text{Acceptance angle } \theta_{as} = \sin^{-1} (NA / \cos \gamma)$$

## Optical modes and configurations:

Optical fiber  $\rightarrow$  dielectric waveguide that operates at optical frequencies.

$\rightarrow$  It is cylindrical.

$\rightarrow$  It confines EM energy in the form of light.

The propagation of light is described in terms of set of guided EM waves called modes of waveguide. These guided modes are bound or trapped modes.

Structure:

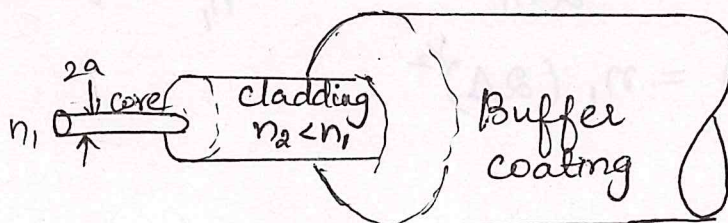



Core - Single solid dielectric cylinder of radius  $a$  & index of refraction  $n_1$ .

Cladding - Core is surrounded by a solid dielectric.  $n_2 < n_1$ .

- It adds mechanical strength to fiber.
- It protects the core from absorbing surface contaminants.

### Mode analysis for Optical propagation through fibers:

Mode analysis is based on the nature of light and allows to apply Maxwell equations to explain its propagation. In EM wave, electric and magnetic fields are orthogonal to each other.

If electric field is along  $x$ -axis, magnetic field is along  $y$ -axis, then direction of propagation of light will be along  $z$ -direction.

Plane wave is linearly polarized with polarization vector  $e_x$ . Another electric field with  $e_y$ .

Polarisation refers to orientation of EM field with respect to some plane.

$$E_x(z, t) = \text{Re}(E) = e_x E_0 \cos(\omega t - \beta z)$$

$$E(z, t) = \exp[j(\omega t - \beta z)]$$

$e_x$  - unit vector along  $x$ -direction

$\omega$  - angular frequency

$\beta$  -  $z$  component of propagation constant

$E_0$  - amplitude of electric vector along  $z$ -direction



Assume another polarized wave  $E_y(z, t)$  is orthogonal and independent of  $E_x(z, t)$ .

$$E_y(z, t) = \text{Re}(E) = e_y E_{oy} \cos(\omega t - \beta z + \delta)$$

$e_y$  - unit vector along y-direction

$\delta$  - phase difference between two orthogonal

$E_{oy}$  - Amplitude of electric vector. vectors.

Resultant of two waves can be,

$$E(z, t) = E_x(z, t) + E_y(z, t)$$

When  $\delta = 0$ , two orthogonal waves are in phase and resultant wave is linearly polarized.

$$\therefore |\vec{E}| = \sqrt{E_{ox}^2 + E_{oy}^2}$$

Polarisation vector makes an angle  $\theta$  with x-axis,

$$\theta = \tan^{-1} \left( \frac{E_{oy}}{E_{ox}} \right)$$

General eqn of ellipse is, (elliptically polarized)

$$\left( \frac{E_x}{E_{ox}} \right)^2 + \left( \frac{E_y}{E_{oy}} \right)^2 - 2 \left( \frac{E_x}{E_{ox}} \right) \left( \frac{E_y}{E_{oy}} \right) \cos \delta = \sin^2 \delta$$

When  $E_{ox} = E_{oy} = E_0$

$$\delta = 2\pi m \pm \frac{\pi}{2}$$

Circularly polarised wave eqn

$$E_x^2 + E_y^2 = E_0^2$$



## Electromagnetic waves:

EM wave propagation is provided by Maxwell's equations. For free space,

$$\nabla \times E = -\frac{\partial B}{\partial t} \quad ; \quad \nabla \times H = \frac{\partial D}{\partial t} \quad ;$$

$$\nabla \cdot D = 0 \quad ; \quad \nabla \cdot B = 0$$

$$D = \epsilon E \quad ; \quad B = \mu H$$

$$\nabla \times (\nabla \times E) = -\mu \epsilon \frac{\partial^2 E}{\partial t^2}$$

$$\nabla \times (\nabla \times H) = -\mu \epsilon \frac{\partial^2 H}{\partial t^2}$$

But,  $\nabla \times (\nabla \times E) = \nabla(\nabla \cdot E) - \nabla^2 E$

So, non dispersive wave equations

$$\nabla^2 E = \mu \epsilon \frac{\partial^2 E}{\partial t^2} \quad ; \quad \nabla^2 H = \mu \epsilon \frac{\partial^2 H}{\partial t^2}$$

## Transverse Electric & Transverse Magnetic modes:

Wave equations in cylindrical coordinates are

$$\frac{\partial^2 E_z}{\partial r^2} + \frac{1}{r} \frac{\partial E_z}{\partial r} + \frac{1}{r^2} \frac{\partial^2 E_z}{\partial \phi^2} + q^2 E_z = 0$$

$$\frac{\partial^2 H_z}{\partial r^2} + \frac{1}{r} \frac{\partial H_z}{\partial r} + \frac{1}{r^2} \frac{\partial^2 H_z}{\partial \phi^2} + q^2 H_z = 0$$

When  $E_z = 0$ , modes are Transverse Electric (TE) modes

$H_z = 0$ , modes are Transverse Magnetic (TM) modes.

Hybrid modes exist, when  $E_z$  &  $H_z$  are non zero.

If both are zero, TEM modes exist.

Wave equations for step index fiber:

$$\frac{\partial^2 F_1}{\partial r^2} + \frac{1}{r} \frac{\partial F_1}{\partial r} + \left( q^2 - \frac{v^2}{r^2} \right) F_1 = 0.$$



where  $u^2 = k_1^2 - \beta^2$ .  $k_1 = 2\pi n_1 / \lambda$

Inside core,  $E_z(r < a) = A J_v(ur) e^{jv\phi} e^{j(\omega t - \beta z)}$

$H_z(r < a) = B J_v(ur) e^{jv\phi} e^{j(\omega t - \beta z)}$

where  $A$  &  $B$  are constants.

Outside core,  $E_z(r > a) = C K_v(ur) e^{jv\phi} e^{j(\omega t - \beta z)}$

$H_z(r > a) = D K_v(ur) e^{jv\phi} e^{j(\omega t - \beta z)}$

$$E_{z1} - E_{z2} = A J_v(ua) - C K_v(ua) = 0 \quad \omega^2 = \beta^2 - k_2^2$$

$$E_{\phi 1} - E_{\phi 2} = -\frac{j}{u^2} \left[ A \frac{jv\beta}{a} J_v(ua) - B \omega \mu_0 J_v'(ua) \right] - \frac{j}{\omega^2} \left[ C \frac{jv\beta}{a} K_v(ua) - D \omega \mu_0 K_v'(ua) \right] = 0$$

$$H_{z1} - H_{z2} = B J_v(ua) - D K_v(ua) = 0$$

$$H_{\phi 1} - H_{\phi 2} = -\frac{j}{u^2} \left[ B \frac{jv\beta}{a} J_v(ua) + A \omega \epsilon_0 u J_v'(ua) \right] - \frac{j}{\omega^2} \left[ D \frac{jv\beta}{a} K_v(ua) + C \omega \epsilon_0 u K_v'(ua) \right]$$

By evaluating these equations,

$$(J_v + K_v) (k_1^2 J_v + k_2^2 K_v) = \frac{\beta v}{a} \left( \frac{1}{u^2} + \frac{1}{\omega^2} \right)$$

where  $J_v = \frac{J_v'(ua)}{u J_v(ua)}$  &  $K_v = \frac{K_v'(ua)}{u K_v(ua)}$

For TE<sub>0m</sub> modes,  $J_0 + K_0 = 0$

$$\frac{J_1(ua)}{u J_0(ua)} + \frac{K_1(ua)}{u K_0(ua)} = 0$$

For TM<sub>0m</sub> modes,  $k_1^2 J_0 + k_2^2 K_0 = 0$

$$\frac{k_1^2 J_1(ua)}{u J_0(ua)} + \frac{k_2^2 K_1(ua)}{u K_0(ua)} = 0$$



## Modes in a Planar guide:

Planar waveguide consists of slab of dielectric with refractive index  $n_1$ , sandwiched between two regions of lower refractive index  $n_2$ .

The component of phase propagation constant in  $z$  direction  $\beta_z = n_1 k \cos \theta$ .

$x$  direction  $\beta_x = n_1 k \sin \theta$

Electric field distribution in  $x$  direction with only periodic  $x$  dependence is mode.

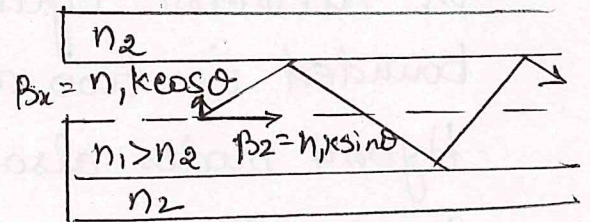

A specific mode is obtained when angle between propagation vectors & interface have a particular value.

TE mode  $\rightarrow$  H field is in the direction of propagation,  $E_z = 0$

TM mode  $\rightarrow$  E field is in the direction of propagation,  $H_z = 0$

TEM mode  $\rightarrow$  Total field lies in transverse plane,  $E_z = H_z = 0$

## Phase and Group velocity:

Wavefront  $\rightarrow$  For plane waves, some constant <sup>phase</sup> points form a surface.

Phase velocity  $\rightarrow V_p = \omega / \beta$

Group velocity  $\rightarrow V_g = \delta \omega / \delta \beta$

Propagation constant  $\rightarrow \beta = n_1 \frac{2\pi}{\lambda} = n_1 \frac{\omega}{c}$

$$V_p = \frac{\omega}{\beta} = \frac{c}{n_1}$$

$$V_g = \frac{d\omega}{d\beta} \times \frac{d\beta}{d\lambda} = \frac{d\omega}{d\lambda} \times \frac{d\lambda}{d\beta} = \frac{d}{d\lambda} \left( n_1 \frac{2\pi}{\lambda} \right)^{-1} \left( \frac{-\omega}{\lambda} \right)$$



$$= \frac{-\omega}{2\pi\lambda} \left( \frac{1}{\lambda} \frac{dn_1}{d\lambda} - \frac{n_1}{\lambda^2} \right)^{-1}$$

$$= \frac{c}{n_1 - \lambda \frac{dn_1}{d\lambda}} = \frac{c}{N_g} \quad \text{where } N_g \text{ - group index of guide.}$$

### Modes in Cylindrical Optical fibers:

Planar guide TE & TM modes are obtained in dielectric cylinder. Cylindrical waveguide is bounded in two dimensions. They are  $TE_{lm}$  &  $TM_{lm}$  modes. Hybrid modes also occur, these designated as  $HE_{lm}$  &  $EH_{lm}$ .

### Linearly polarized (LP) modes:

Optical fibers satisfy weakly guiding approximation where  $\Delta \ll 1$ . For weakly guiding fibers with dominant forward propagation, mode theory gives dominant transverse field components.

### Degenerate modes:

As  $\Delta$  in weakly guiding fibers is very small, then EH-HE mode pairs occur which have almost identical propagation constants. Such modes are said to be degenerate.

The relationship between the traditional HE, EH, TE and TM mode designations and the  $LP_{lm}$  mode designations is shown in table.



Linearly polarized	Exact
LP <sub>01</sub>	HE <sub>11</sub>
LP <sub>11</sub>	HE <sub>21</sub> , TE <sub>01</sub> , TM <sub>01</sub>
LP <sub>21</sub>	HE <sub>31</sub> , EH <sub>11</sub>
LP <sub>02</sub>	HE <sub>12</sub>
LP <sub>12</sub>	HE <sub>22</sub> , TE <sub>02</sub> , TM <sub>02</sub>
LP <sub>lm</sub>	HE <sub>2m</sub> , TE <sub>0m</sub> , TM <sub>0m</sub>
LP <sub>lm</sub> (l ≠ 0 or 1)	HE <sub>l+1,m</sub> , EH <sub>l-1,m</sub>

Wave eqn under cylindrical coordinates

$$\frac{d^2\psi}{dr^2} + \frac{1}{r} \frac{d\psi}{dr} + \frac{1}{r^2} \frac{d^2\psi}{d\phi^2} + |n^2 k^2 - \beta^2| \psi = 0$$

where  $\psi$  is field (E or H)

$n_1$  - core refractive index

$k$  - propagation constant

$r, \phi$  - cylindrical coordinates.

The propagation constants of guided modes  $\beta$  lie in the range;  $n_2 k < \beta < n_1 k$ .

$n_2$  - refractive index of cladding.

In Bessel,

$$E(r) = G J_0(kr) = G J_0(\frac{R}{R_0} kr)$$

$R > 1$

$u$  &  $w$  are eigen values of core & cladding

$$u = a(n_1^2 k^2 - \beta^2)^{1/2}$$

$$v = a(\beta^2 - n_2^2 k^2)^{1/2}$$

Normalized prop const

$$b = 1 - \frac{u^2}{v^2} = \frac{(\beta/k)^2 - n_2^2}{2n_1^2 \Delta}$$

$0 < b < 1$

Normalized Frequency:

The sum of squares of  $u$  &  $w$  defines a useful quantity is the normalized frequency.

$$V = (u^2 + w^2)^{1/2} = ka(n_1^2 - n_2^2)^{1/2}$$



$$V = \frac{2\pi a}{\lambda} (\text{NA}) = \frac{2\pi a}{\lambda} n_1 (\Delta)^{1/2}$$

$V$  - dimensionless parameter - It is V no. (or) value of fiber.

$$\text{No. of guided modes } m = \frac{V^2}{2}$$

### Fiber Materials:

In selecting materials of fiber, no. of requirements must be satisfied.

- \* To make long, thin, flexible fiber from material.
- \* Material must be transparent to guide light effectively
- \* Materials have slightly different refractive indices for core & cladding.

Materials satisfy these requirements are glass & plastics.

Glass fiber → consists of silica  
→ moderate loss fiber

Plastic fiber → less widely used due to high attenuation  
→ Used for short distance applications.  
→ provides greater mechanical strength.

### 1) Glass Fibers:

- Made up of mixtures of metal oxides, sulphide, etc.
- random n/w of well defined structure.
- do not have well defined melting point. So, temperature increases, it begins to soften, becomes viscous liquid. Melting is used in glass manufacture.



To produce two different indices for core & cladding, dopants added to silica.

Addition of  $P_2O_5$  &  $GeO_2$  increases refractive index, silica with fluorine or  $B_2O_5$  decreases it.

- ex:
- 1)  $GeO_2 - SiO_2$  core ;  $SiO_2$  cladding
  - 2)  $P_2O_5 - SiO_2$  core ;  $SiO_2$  cladding
  - 3)  $SiO_2$  core ;  $B_2O_3 - SiO_2$  cladding
  - 4)  $GeO_2 - B_2O_3 - SiO_2$  core ;  $B_2O_3 - SiO_2$  cladding

## 2) Active glass fibers:

Include rare elements (57-71) into passive glass gives resultant new optical & magnetic properties. This allows material to perform amplification, attenuation etc. Doping carried out for silica, tellurite & halide glasses.

Commonly used materials: erbium/neodymium.

## 3) Chalcogenide Glass fibers:

These are discovered to make use of nonlinear properties of glass fibers. It contains S, Se, or Te. & mostly used glass is  $As_2 - S_3$ . Insertion loss 1db/km. Core -  $As_{40}S_{58}Se_2$ .  
(cladding) one from Br, Cl, Cd, Ba, Si

## A) Plastic Optical Fibers:

- made up of plastic. Core is made up of Polymethylmethacrylate (PMMA) or Perfluorinated Polymer (PFP).

- Plastic have more attenuation
- Used for short distance.



## 5) Fluoride glass fibers:

Halide glass fiber contains fluorine, chlorine, bromine & iodine. Common halide glass fiber is 'metal fluoride glass'. It uses  $ZrF_4$ . Other constituents  $ZrF_4$  (54%),  $BaF_2$  (20%),  $LaF_3$  (4.5%),  $NaF$  (18%),  $AlF_3$  (3.5%).  
Insertion loss 0.01 to 0.001 db/km.

## Fiber fabrication techniques:

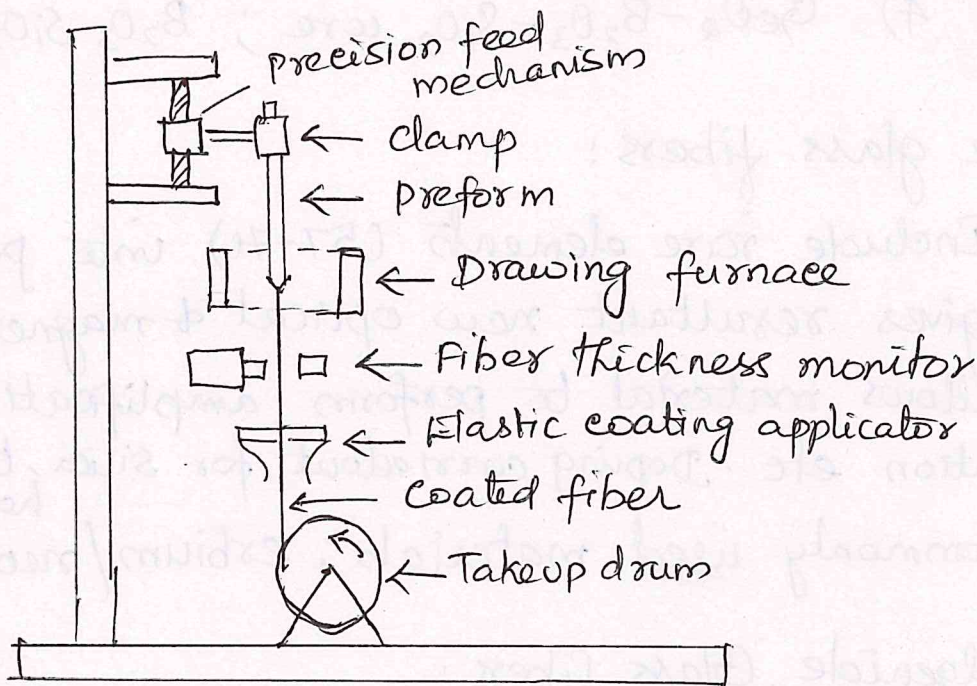

Fiber drawing apparatus.

- \* Direct-melt method - Follows traditional glass making procedures in that optical fibers are made directly from molten state of purified component of silica glass.
- \* Vapor-phase oxidation process - Pure vapors of metal halides react with  $O_2$  to form  $SiO_2$ . They are sintered to form glass rod, (ie) preform. It is fed into circular heated called



drawing furnace. It can be drawn into filament becomes optical fiber. Fiber thickness monitor is used for speed regulation. Elastic coating protects the fiber from contaminants.

Outside Vapor phase Oxidation:

Layer of  $SiO_2$  called soot is deposited from burner onto a rotating graphite. Glass soot adheres into bait rod, glass preform is built up.

When deposition process is completed, mandrel is removed and porous tube is vitrified to a clear glass preform. It is mounted in a fiber drawing tower & made into fibers. The central hole in the tube preform collapses during process.

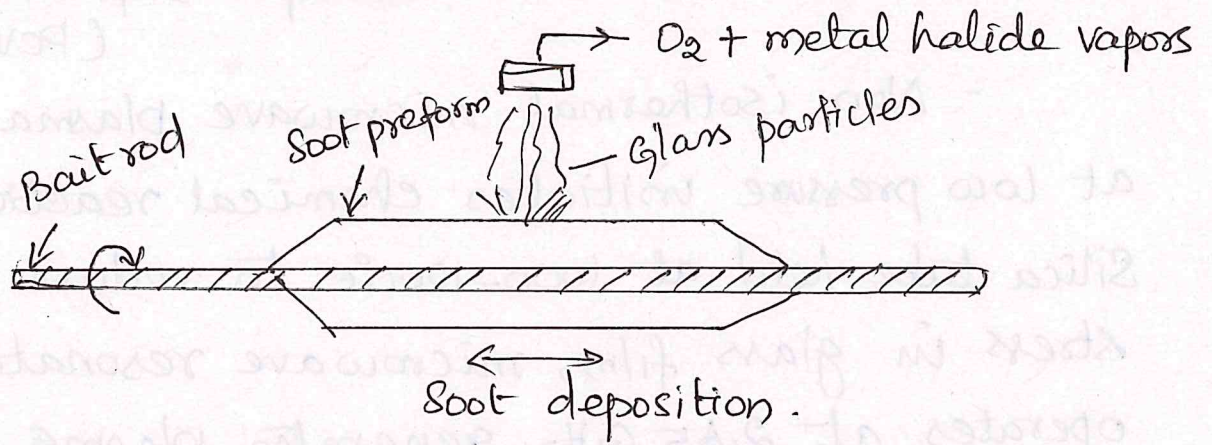

Modified Chemical Vapor Deposition (MCVD):

It is used to produce very low loss graded index fiber. Glass particles arise from metal halides flow thro' silica tube. As  $SiO_2$  deposited, they are sintered into glass layer



by an oxyhydrogen torch which travels back & forth along the tube. When glass is deposited, vapor flow is shut off & tube is heated to collapse into solid rod preform. Fiber is drawn from preform rod will have a core that consists of vapor deposited material and cladding that consists of original silica tube.

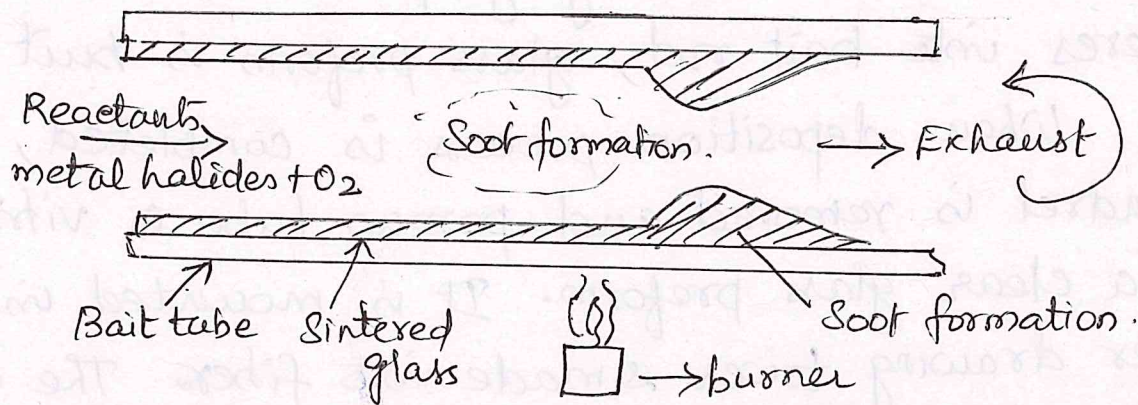

### Plasma-Activated Chemical Vapor Deposition: (PCVD)

- Non isothermal microwave plasma operating at low pressure initiates chemical reaction. With silica tube held at 1000-1200°C to reduce mechanical stress in glass film, microwave resonator operates at 2.45 GHz generates plasma inside the tube to activate chemical reaction. This deposits glass material on tube wall. There is no soot formation. No sintering is required. When one has deposited the desired glass thickness, tube is collapsed into preform.



## Apparatus for VAD.

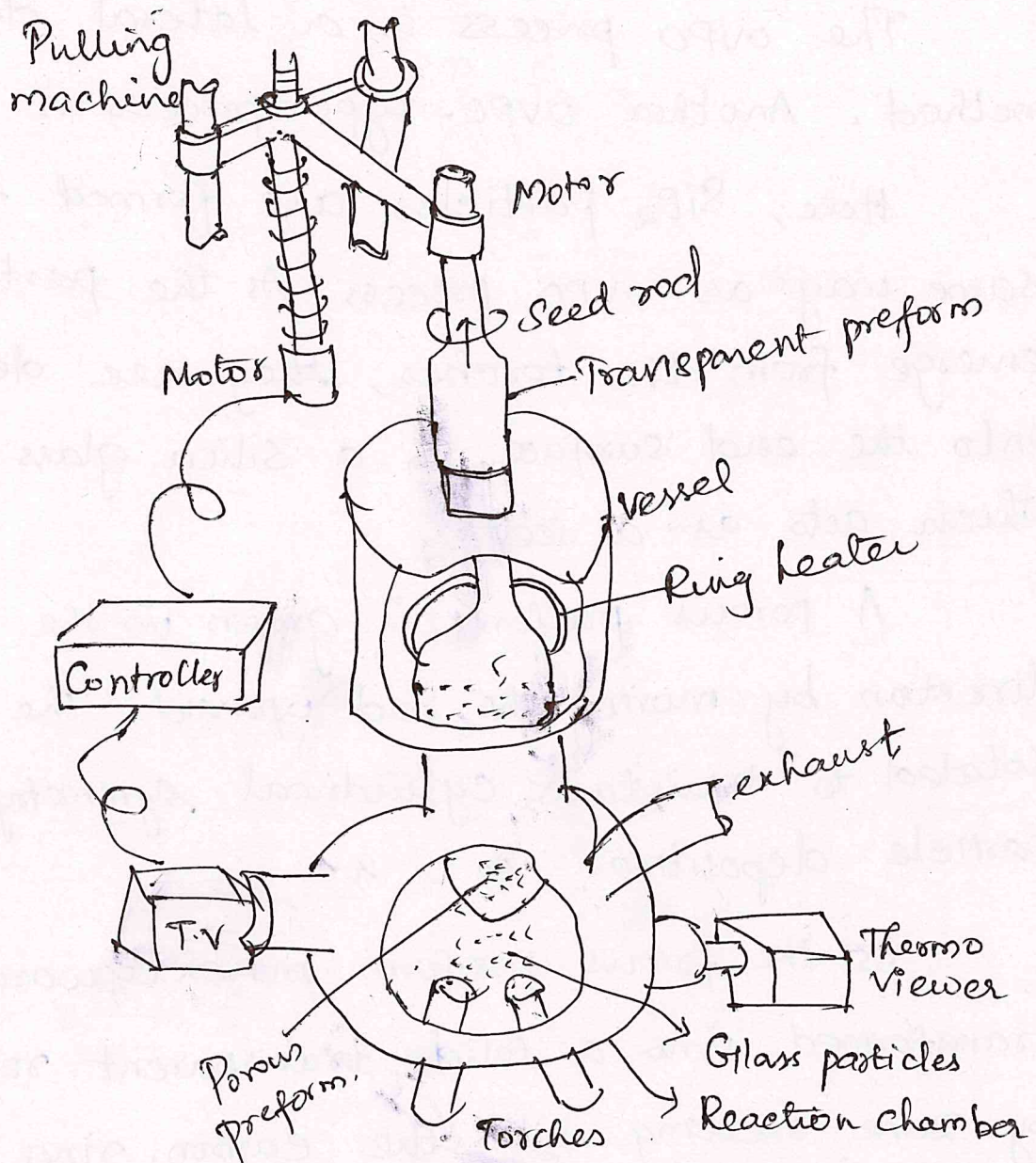

- Advantages:
1. Preform has no central holes as occurs with OVPO process.
  2. Preform can be fabricated in continuous lengths which can affect process costs and product yields.
  3. The deposition chamber and zone-melting ring heater are tightly connected to each other in the same enclosure allows the achievement of clean environment.



## Vapor-Phase Axial Deposition (VAD):

The OVPO process is a lateral deposition method. Another OVPO-type process is VAD method.

Here,  $\text{SiO}_2$  particles are formed in the same way as OVPO process. As the particles emerge from the torches, they are deposited onto the end surface of a silica glass rod which acts as a seed.

A porous preform is grown in the axial direction by moving the rod upward. The rod is rotated to maintain cylindrical symmetry of the particle deposition.

As the porous preform moves upward, it is transformed into a solid, transparent rod preform by zone melting with the carbon ring heater.

The resultant preform can be drawn into fiber by heating it in another furnace as in fiber drawing apparatus.

Both step and graded index fibers (both single & multi mode) can be by VAD method.

Apparatus for VAD is shown in the following figure.



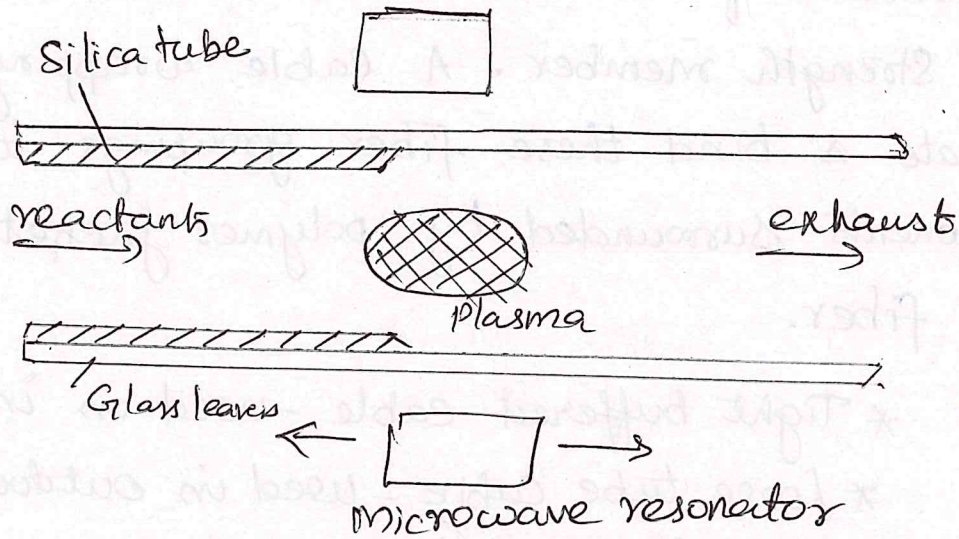

Schematic of PCVD.

### Fiber Optic Cables:

**Cable Structures:** One of the mechanical property is max. allowable axial load on the cable, since it determines length of cable that is installed.

In copper cables, wires are principal load-bearing members of cable, elongation 20% is possible without fracture.

Steel wire has been used for reinforcing electric cables & used as strength member for fiber cable.

Also, Plastic strength members & Synthetic yarns are used. ex: Tough yellow synthetic nylon - aramid

### Configuration:

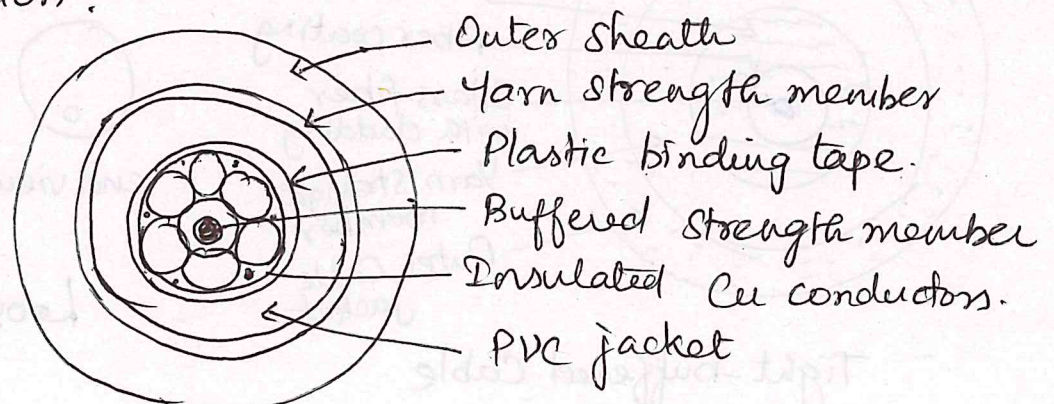



Individual fibers are wound around central buffered strength member. A cable wrapping tape encapsulate & bind these fiber groupings together. All components surrounded by polymer jacket that protects fiber.

Types: \* Tight buffered cable - used in indoors  
\* loose tube cable - used in outdoor.

In tight buffered, each fiber is encapsulated by plastic fiber (900  $\mu\text{m}$ ). It is 4 times the diameter, 5 times thickness of coating material.

In loose tube, std coated fibers are enclosed in a thermoplastic tube. Fibers in the cable are longer than it. It isolates fiber from surrounding. The tube is filled with gel that acts as buffer.

Ribbon cable is extension of tight buffered cable. Here, fibers are encapsulated in a plastic buffer to form long continuous ribbon. No. of fibers in a ribbon from 4-12.

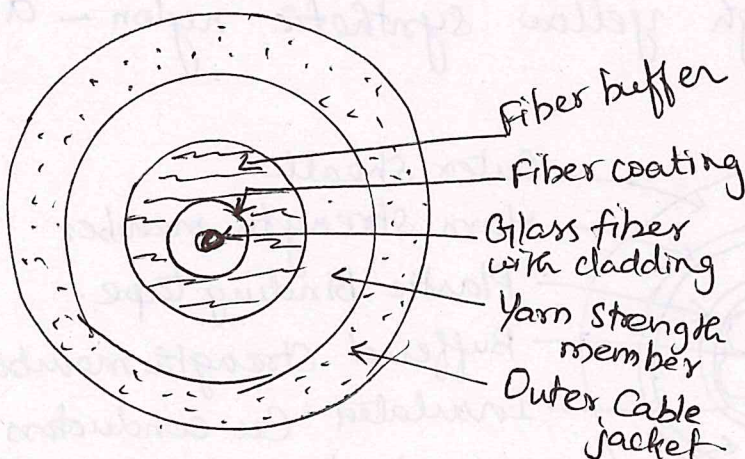

Tight-buffered cable

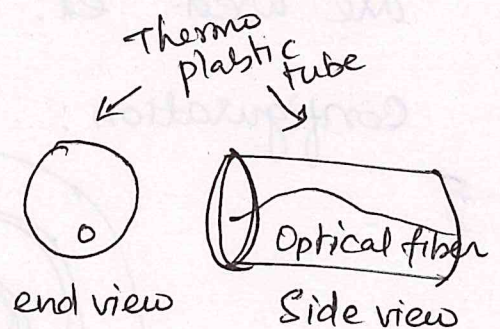

Loose-tube cable



## Indoor Cables:

- Used for interconnecting instruments, for distributing signals among users, for connections to printers, short patch cords in telecommunication equipment racks.

Types: 1) Interconnect Cable - It serves light-duty low fiber count indoor applications such as fiber to desk links, patch cords, point to point runs in trays. This is flexible, compact and light weight.

2) Breakout or fanout cable - It consists of 12 tight-buffered fibers around a central strength member. Such cables serve low to medium fiber count applications. This cable allows easy installation of connectors in the cable.

3) Distribution cable - It consists of individual tight buffered fibers around central strength member. This cable serves network applications for sending voice, video & data signals.

## Outdoor Cables:

- 1) Aerial cable - mounted outside between building or on poles. Two popular designs are,
  - \* Self supporting cable - Contains internal strength member strung between poles without additional support
  - \* Facility Supporting cable - strength member is strung between poles & cable is clipped to this member.



2) Armored Cable - Used for direct-burial or underground duct applications, has one or more layers of steel wire below a layer of polyethylene jacket.

3) Underwater Cable - Submarine cable is used in rivers, lakes and ocean environments. Such cables are exposed to high water pressure. This can be used in rivers, lakes and ocean environments. Such cables are run under ocean.

### classification of Optical fiber:

Step index fiber: The refractive index of core is uniform throughout and undergoes an abrupt change at cladding boundary.

Graded-index fiber: The refractive index of core is made to vary as a function of radial distance from the centre of fiber.

Single mode step index fiber:

- It allows propagation of only one transverse EM mode. Core diameter is small.

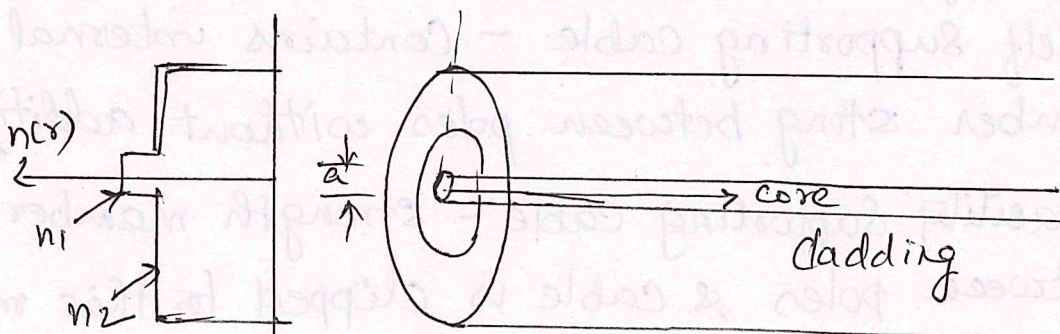



## Multimode Step index fiber:

A multimode step index fiber with core diameter 50  $\mu\text{m}$ , large enough to allow propagation of many modes within core. It allows finite no. of guided modes along the channel.

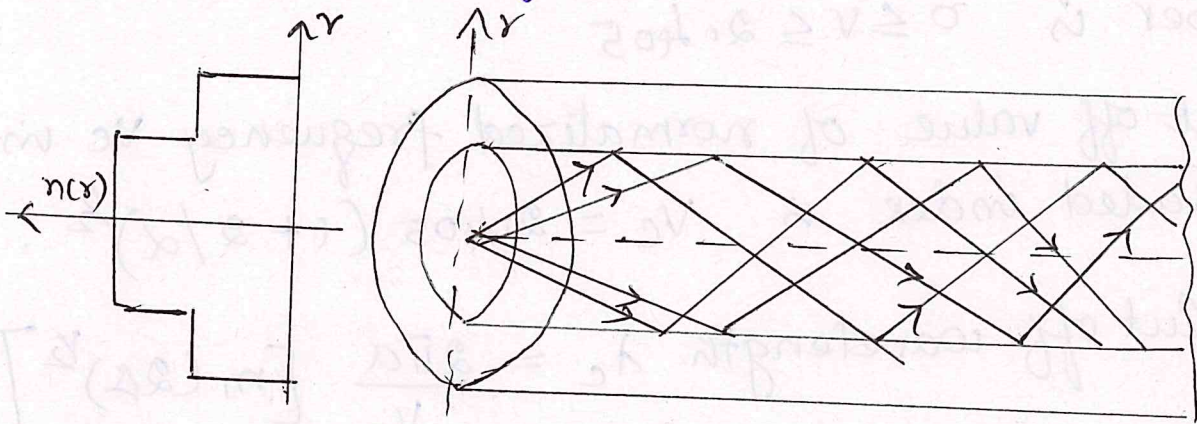

## Advantages of multimode fibers:

- \* Inherent optical sources can't efficiently coupled
- \* Large numerical aperture, facilitates easy coupling to optical sources.
- \* low tolerance requirements for connectors.

## Graded index fiber:

Core refractive index is not uniform. Its variation maybe represented as,

$$n(r) = n_1 (1 - 2\Delta (r/a)^\alpha)^{1/2} \quad \text{for } r < a$$

$$= n_1 (1 - 2\Delta)^{1/2} = n_2 \quad \text{for } r \geq a$$

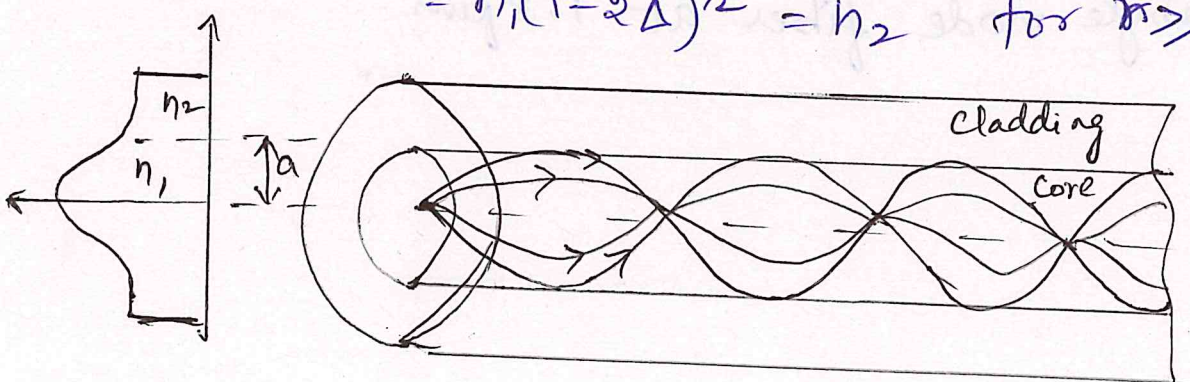



## Single-mode fibers (SM fiber)

Advantage of single mode is signal dispersion caused by delay differences between modes is avoided.

→ Single mode propagation of LP<sub>01</sub> in step index fiber is  $0 \leq V \leq 2.405$

→ Cut off value of normalized frequency  $V_c$  in graded index is  $V_c = 2.405 (1 + 2/\alpha)^{1/2}$

→ Cut off wavelength  $\lambda_c = \frac{2\pi a}{V_c} [n_1 (2\Delta)^{1/2}]$   
 $\lambda_c / \lambda = V / V_c$

Thus, for step index fiber,  $V_c = 2.405$ ,

cut off wavelength  $\lambda_c = V\lambda / 2.405$

→ The effective cut off wavelength  $\lambda_c$  is largest wavelength at which higher order (LP<sub>11</sub>) mode power relative to fundamental mode (LP<sub>01</sub>) power is reduced to 0.1 db. The range of wavelength recommended to avoid modal noise and dispersion problems is: 1100 to 1280 nm for single mode fiber at 1.3  $\mu\text{m}$ .

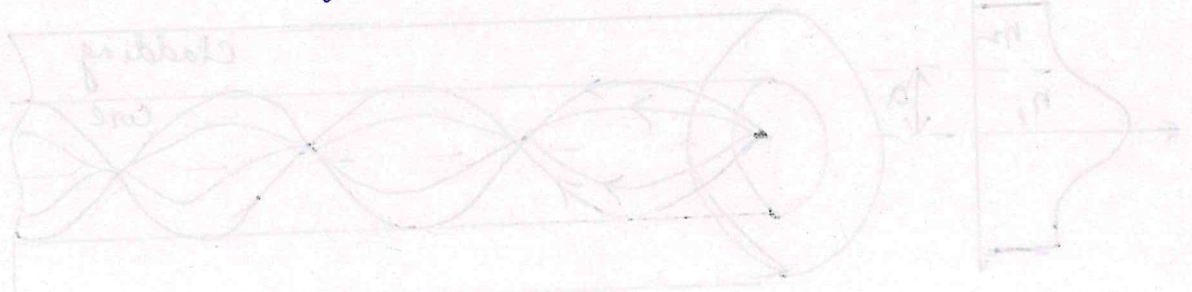



## Effective Refractive Index:

The rate of change of phase of fundamental LP<sub>01</sub> mode propagating along a straight fiber is determined by propagation constant  $\beta$ .

It is related to the wavelength of LP<sub>01</sub> mode  $\lambda_{01}$  by the factor  $2\pi$ , since  $\beta$  gives the increase in phase angle per unit length.

$$\therefore \beta \lambda_{01} = 2\pi \quad \text{or} \quad \lambda_{01} = 2\pi / \beta$$

Effective refractive index for single mode fiber is referred as phase index or normalised phase change coefficient  $n_{\text{eff}}$ , by the ratio of propagation constant of fundamental mode to vacuum propagation constant.

$$n_{\text{eff}} = \beta / k$$

Hence, the wavelength of fundamental mode  $\lambda_{01}$  is smaller than vacuum wavelength  $\lambda$  by factor  $1/n_{\text{eff}}$  where  $\lambda_{01} = \lambda / n_{\text{eff}}$ .







## Problems:

- 1) A silica optical fiber has core refractive index of 1.5 and cladding refractive index of 1.47. Determine
- critical angle at core-cladding interface,
  - NA for the fiber
  - acceptance angle in air for fiber

a) Critical angle  $\phi_c = \sin^{-1}(n_2/n_1)$

$$\phi_c = \sin^{-1}(1.47/1.5) = 78.5^\circ$$

b)  $NA = \sqrt{n_1^2 - n_2^2} = \sqrt{1.5^2 - 1.47^2} = 0.3$

c) Acceptance angle  $\theta_a = \sin^{-1} NA = \sin^{-1} 0.3 = 17.4^\circ$

- 2) A typical relative refractive index difference for an optical fiber designed for long distance transmission is 1%. Estimate NA and solid acceptance angle in air for the fiber when core index is 1.46. Calculate the critical angle at core-cladding interface within the fiber.

$$NA = n_1 (\Delta)^{1/2} = 1.46 (2 \times 0.01)^{1/2} = 0.21$$

For small angles, solid acceptance angle is

$$\tau = \pi \theta_a^2 = \pi \sin^2 \theta_a$$

$$= \pi (NA)^2 = \pi \times 0.04 = 0.13 \text{ rad.}$$

$$\Delta = 1 - (n_2/n_1) = 1 - 0.01 \Rightarrow 0.99 = n_2/n_1$$

$$\text{Critical angle } \phi_c = \sin^{-1} n_2/n_1 = \sin^{-1}(0.99) = 81.9^\circ$$

- 3) Assume that there is a glass rod of refractive index 1.5, surrounded by air. Find critical incident angle.



Refractive index of glass  $n_1 = 1.5$

Refractive index of air  $n_2 = 1.0$

Snell's law:  $n_1 \sin \phi_1 = n_2 \sin \phi_2$

$$\therefore \sin \phi_1 = \frac{n_2}{n_1} \sin \phi_2$$

From defn of critical angle,  $\phi_2 = 90^\circ$  &  $\phi_1 = \phi_c$

$$\sin \phi_c = \frac{n_2}{n_1} \sin 90^\circ = \frac{1.0}{1.5} (1) = 0.67$$

$$\phi_c = \sin^{-1} 0.67 = 41.81^\circ$$

4) An optical fiber in air has an NA of 0.4. Compare acceptance angle for meridional rays with that for skew rays which change direction by  $100^\circ$  at each reflection

$$\text{Acceptance angle } \theta_a = \sin^{-1} \text{NA} = \sin^{-1} 0.4 = 23.6^\circ$$

Skew rays change direction by  $100^\circ$ ,  $\therefore \gamma = 50^\circ$

$$\text{For skew rays, } \theta_{as} = \sin^{-1} (\text{NA} / \cos \gamma) = \sin^{-1} (0.4 / \cos 50^\circ) = 38.5^\circ$$

5) Estimate max. core diameter of fiber with  $\Delta = 1.5\%$ , core refractive index 1.48 for single mode operation. Fiber operates at same wavelength  $0.85 \mu\text{m}$ . Also, estimate max. core diameter when  $\Delta$  reduced by factor 10.

Max. V value for single mode operation is 2.4

$$V_c = \frac{2\pi a}{\lambda_c} (n_1 (2\Delta)^{1/2})$$

$$\therefore a = (2.4 \times 0.85 \times 10^{-6}) / (2\pi \times 1.48 \times \sqrt{0.03})$$

$$a = 1.3 \mu\text{m}$$

$\therefore$  core diameter =  $2.6 \mu\text{m}$ .

$$\text{A reduced by 10, } a = (2.4 \times 0.85 \times 10^{-6}) / (2\pi \times 1.48 \times \sqrt{0.003}) = 4 \mu\text{m}$$

$\therefore$  core diameter =  $8 \mu\text{m}$



6. Find normalized frequency for a given fiber with  $n_1 = 1.455$ ,  $n_2 = 1.448$  and  $a = 5 \mu\text{m}$  for wavelength  $\lambda_0 = 1150 \text{ nm}$ .

$$\text{Normalized frequency } V = \frac{2\pi a (n_1^2 - n_2^2)^{1/2}}{\lambda}$$

$$V = \frac{2\pi \times 5 \times 10^{-6} (1.455^2 - 1.448^2)^{1/2}}{1150 \times 10^{-9}} = 3.894$$

7. A manufacturing engineer wants to make an optical fiber that has a core index of 1.48 and cladding index of 1.478. What should be the core size for single mode operation at 1550 nm?

For single mode operation  $V \leq 2.405$ .

$$V = \frac{2\pi a \sqrt{n_1^2 - n_2^2}}{\lambda} \Rightarrow a = \frac{V \lambda}{2\pi \sqrt{n_1^2 - n_2^2}}$$

$$a = \frac{2.405 \times 1.55 \mu\text{m}}{2\pi} \frac{1}{\sqrt{1.48^2 - 1.478^2}} = 7.7 \mu\text{m}$$

8. Calculate cut off wave length of signal through fiber with core refractive index 1.5 and cladding 1.46. Core radius is  $25 \mu\text{m}$ . Normalized frequency is 2.405

$$n_1 = 1.5 \quad n_2 = 1.46$$

$$\Delta = \frac{n_1 - n_2}{n_1} = 0.0267$$

$$\lambda_c = \left( \frac{2\pi a n_1}{2.405} \right) (2\Delta)^{1/2}$$

$$= \frac{2\pi \times 25 \times 1.5}{2.405} (2 \times 0.0267)^{1/2}$$

$$\lambda_c = 22.59 \mu\text{m}$$



9. Consider a multimode step index fiber with  $62.5 \mu\text{m}$  core diameter and a core-cladding index difference of  $1.5\%$ . If the core refractive index is  $1.48$ , estimate the normalized frequency of the fiber and the total no. of modes supported in the fiber at a wavelength of  $850 \text{ nm}$ . May-19

Given  $a = 62.5 \mu\text{m}$ ,  $\Delta = 1.5\%$ ,  $n_1 = 1.48$ ,  $\lambda = 850 \text{ nm}$

Normalized frequency  $V = \frac{2\pi a}{\lambda} n_1 (\Delta)^{1/2}$

$$V = \frac{2\pi \times 31.25 \mu\text{m} \times 1.48}{0.85 \mu\text{m}} \sqrt{2 \times 0.015} = 59.2$$

Total no. of modes  $M = \frac{V^2}{2} = \frac{59.2^2}{2} = 1752$

10. A graded index fiber with a core with a parabolic refractive index profile ( $\alpha = 2$ ) and diameter of  $50 \mu\text{m}$ . The fiber has numerical aperture of  $0.2$ . Estimate the no. of guided modes propagating in the fiber when the transmitted light has wavelength  $1 \mu\text{m}$ .

Given  $\alpha = 2$ ,  $a = 25 \mu\text{m}$ ,  $NA = 0.2$ ,  $\lambda = 1 \mu\text{m}$

Normalized frequency for single mode operation

$$V = \frac{2\pi a}{\lambda} (NA)$$

$$= 2\pi \times 25 \times 10^{-6} \times 0.2 / 1 \times 10^{-6} = 31 \times 10^{-6} / 1 \times 10^{-6}$$

$$V = 31.42$$

For parabolic profile, no. of mode is

$$M = V^2/4 = 31.42^2/4 = 246.804 \approx 247$$



## Unit II. Transmission characteristics of Optical Fibers

### Introduction:

The signal transmitting through the fiber is degraded by two mechanisms.

- i) Attenuation
- ii) Dispersion.

Attenuation: - Fiber loss or Signal loss.

- Measure of decay of signal strength / loss of light power.
- used to determine the max. transmission distance between transmitter & receiver.
- Also determine no. of repeaters required.

$$\text{Attenuation in db} = 10 \log_{10} \left( \frac{P_i}{P_o} \right)$$

$$\alpha_{\text{db}} L = 10 \log_{10} (P_i / P_o) \quad L \rightarrow \text{Fiber length.}$$

Basic attenuation mechanisms are,

- \* Absorption
- \* Scattering loss
- \* radiative losses.

### Absorption:

Material absorption is a loss mechanism related to material composition and the fabrication process for the fiber.

Absorption is caused by three mechanisms.

- 1) Absorption by atomic defects in glass composition.
- 2) Extrinsic absorption by impurity atoms in glass
- 3) Intrinsic absorption by basic constituents atoms of the material.



## Absorption by Atomic Defects:

\* Atomic defects are imperfections of fiber structure such as missing molecules, high density clusters of atom groups.

\* Absorption effect is most significant when fiber is exposed to ionizing radiation in nuclear reactor, space mission etc. The damages are proportional to intensity of ionizing particles.

## Intrinsic Absorption:

\* It occurs when material is in pure state, no density variation and inhomogeneities. Pure silicate glass has little intrinsic absorption due to its basic material structure in near-infrared region.

\* It results from electronic absorption bands in UV region & from atomic vibration bands in infrared region.

\* When  $\lambda$  increases, UV absorption decreases.

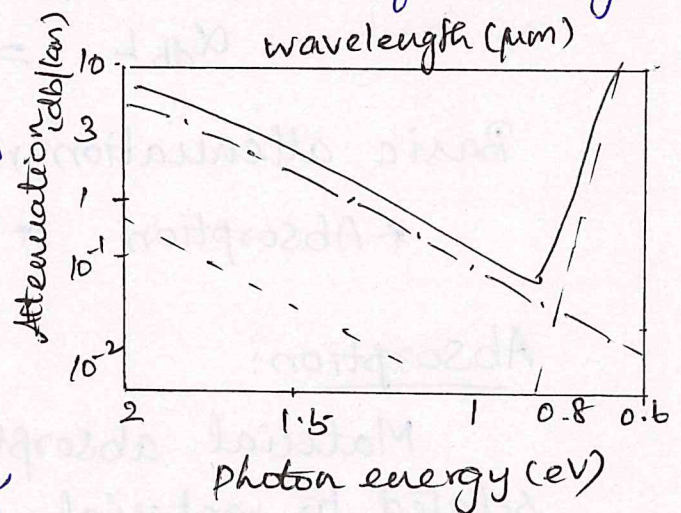

The ultraviolet loss at any wavelength is

$$\alpha_{uv} = \frac{154.2 \times 10^{-2} \times e^{\left(\frac{4.65}{\lambda}\right)}}{46.6 \times +60}$$

$x$  - mole fraction of GeO<sub>2</sub>

$\lambda$  - operating wavelength

$\alpha_{uv}$  - Attenuation in dB/km



The loss in infrared region is

$$\alpha_{IR} = 7.81 \times 10^{11} e^{-48.48/\lambda}$$

Extrinsic Absorption:

- \* Due to transition metal element impurities.
  - Metallic impurities are  $Cr^{3+}$ ,  $Fe^{2+}$ ,  $Ni^{2+}$ ,  $Mn^{3+}$  --
  - This effect of metallic impurities reduced by glass refining technique.
- \* Caused by absorption due to water (OH ion).
  - results from oxyhydrogen flame used for hydrolysis reaction of  $SiCl_4$ ,  $GeCl_4$ .
  - This is reduced by reducing water content in the fiber.

Scattering Losses:

\* This is due to microscopic variations in the material density and composition.

1) Linear Scattering loss:

\* It causes the transfer of some of optical power within one mode to be transferred to another

Types:

- i) Rayleigh Scattering
- ii) Mie Scattering

Rayleigh Scattering:

- Dominant intrinsic loss mechanism.
- occurs in UV region, tail extends upto infrared region.
- results from inhomogeneities of random nature.



The compositional variations may be reduced by improved fabrication;

For a single-component glass, this is given by:

$$\gamma_R = (8\pi^3/3\lambda^4) n^8 p^2 \beta_c k T_F$$

where  $\gamma_R$  - Rayleigh scattering coefficient

$\lambda$  - Optical wavelength

$n$  - refractive index of medium

$p$  - average photoelastic coefficient

$\beta_c$  - isothermal compressibility at fictive temp.

$k$  - Boltzmann constant.

Rayleigh scattering is related to transmission loss factor

$$L = \exp(-\gamma_R L)$$

Mie Scattering:

- This occurs by inhomogeneities in forward direction.
- It results from non perfect cylindrical structure of waveguide and may be caused by fiber imperfections like diameter fluctuations, irregularities in core-cladding interface.

The inhomogeneities can be reduced by,

- removing imperfections due to glass manufacturing process.
- carefully controlled extrusion + coating of fiber
- increasing the fiber guidance by increasing relative refractive index difference



## Non linear Scattering loss:

It causes optical power from one mode to be transferred in either forward or backward direction at different frequency.

### Stimulated Brillouin Scattering (SBS):

SBS is the modulation of light through thermal molecular vibrations within the fiber.

Scattered light appears at LSB & OSB which are separated from incident light from modulation frequency. Incident photon produces a phonon of acoustic frequency & scattered photon. This produces an optical frequency shift which varies with angle.

Frequency shift is a max. in backward direction, reducing to zero in forward direction, making SBS a mainly backward process.

Threshold Power  $P_B = 4.4 \times 10^{-3} d^2 \lambda^2 \alpha_{db} \nu$  watts.

$d$  - fiber core diameter,  $\lambda$  - operating wavelength  
 $\alpha_{db}$  - fiber attenuation.  $\nu$  - Source bandwidth

### Stimulated Raman Scattering:

- A high frequency optical phonon than an acoustic phonon is generated.

- Occurs in both directions.

Threshold optical power in single mode fiber is

$$P_R = 5.9 \times 10^{-2} d^2 \lambda \alpha_{db} \text{ watts.}$$



## Fiber bend loss:

- Fiber suffers radiation losses at bends or curves on their paths.

Types of bends: a) Macroscopic bends  
b) Microscopic bends.

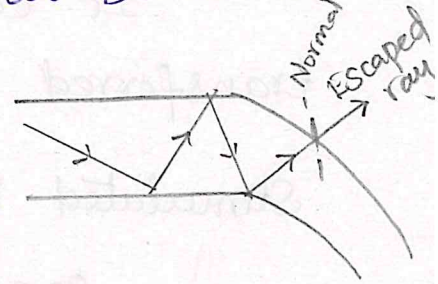

### Macro bending:

→ Occurs when radius of curvature is large compared with diameter.

→ Reduced by design fibers with large refractive difference, operates at shortest wavelength.

Loss represented by radiation attenuation coefficient,

$$\alpha_r = C_1 \exp(-C_2 R)$$

R - Radius of curvature

$C_1, C_2$  - Constant.

Large bending losses tend to occur in multimode fibers at critical radius of curvature

$$R_c = \frac{3n_1^2 \lambda}{4\pi(n_1^2 - n_2^2)^{3/2}}$$

Critical radius of curvature for a single-mode fiber is

$$R_{cs} = \frac{20\lambda}{(n_1^2 - n_2^2)^{3/2}} \left( 2.748 - 0.996 \frac{\lambda}{\lambda_c} \right)^{-3}$$

For multimode fiber, effective no. of modes guided by curved fiber is

$$N_{\text{eff}} = \frac{\alpha}{\alpha + 2} (n_1 k a)^2 \Delta$$

$\alpha$  - graded index profile

$\Delta$  - core-cladding index difference

$n_2$  - refractive index of cladding.



## Macro bending:

For slight bends, the loss is small or is not observed. As the radius of curvature decreases, loss increases exponentially until at a certain critical radius of curvature loss becomes observable.

If a bend radius is made a bit smaller once this threshold point has been reached, losses suddenly become large. It is known that any bound core mode has an evanescent field tail in the cladding which decays exponentially as a function of distance from the core.

Since this field tail moves along with the field in the core, part of energy of propagating mode travels in the fiber cladding.

When a fiber is bent, the field tail on the far side of centre of curvature must move faster to keep up with field core, for the lowest order fiber mode.

At certain critical distance  $x_c$ , from the centre of fiber; the field tail has to move faster than speed of light to keep up with core field. Since this is not possible, the optical energy in the field tail beyond  $x_c$  radiates away.



The amount of optical radiation from a bent fiber depends on field strength at  $x_c$  and on radius of curvature  $R$ . Since, higher order modes are bound less tightly to the fiber core than lower order modes, higher order modes will radiate out of the fiber first.

The change in spectral attenuation caused by macrobending is different from micro bending.

Usually there are no peaks & troughs because in a macro bending no light is coupled back into core from cladding as can happen in case of microbends.

The potential macro bending losses may be reduced by

- designing fibers with relative large refractive index differences.
- Operating at shortest wavelength possible.

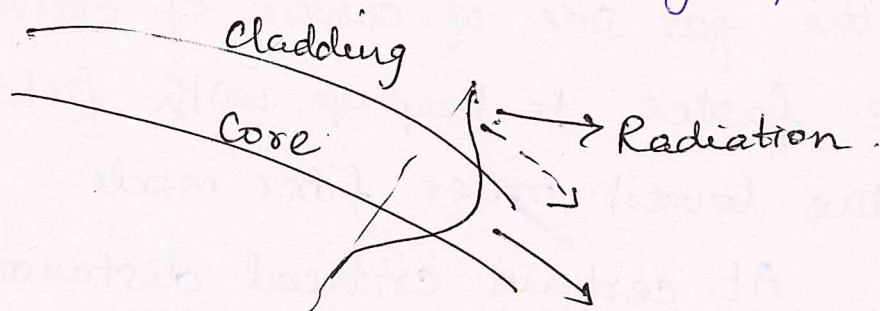

Micro bending:

→ loss due to small bending or distortions.  
Small micro bending is not visible. This losses due to this are temperature related, tensile related.



$k = 2\pi/\lambda$  wave propagation constant.

$N_{\infty}$  - Total no. of modes in a straight fiber.

Micro bending:

→ Small scale fluctuations in radius of curvature of fiber axis. It can be caused either by non-uniformities in manufacturing of fiber or non-uniform lateral pressures created during cabling of fiber.

→ It is reduced by introducing compressible jacket over fiber.

Core and Cladding Loss:

Since, core & cladding have different indices of refraction, they have different attenuation coefficients  $\alpha_1$  &  $\alpha_2$  respectively.

For step index fiber, loss for a mode order  $(v, m)$  is

$$\alpha_{vm} = \alpha_1 \frac{P_{\text{core}}}{P} + \alpha_2 \frac{P_{\text{clad}}}{P}$$

For low order modes,

$$\alpha_{vm} = \alpha_1 + (\alpha_2 + \alpha_1) \frac{P_{\text{clad}}}{P}$$

For graded index fiber, loss at radial distance is

$$\alpha(r) = \alpha_1 + (\alpha_2 - \alpha_1) \frac{n^2(0) - n^2(r)}{n^2(0) - n_1^2}$$

Loss for a given mode is

$$\alpha_{\text{grad. index}} = \frac{\int_0^{\infty} \alpha(r) P(r) r dr}{\int_0^{\infty} P(r) r dr}$$

$P(r)$  - Power density of mode at radial distance  $r$ .



## Dispersion:

It causes distortion for both analog & digital transmission along optical fibers.

It refers to spreading of light pulses thro' fiber.

## Intersymbol Interference:

It causes broadening of transmitted light pulses as they travel along the channel. Each pulse broadens & overlaps with its neighbours. The effect is known as ISI.

## Bandwidth:

For no overlapping of light pulses, digital bit rate  $B_T$  must be less than reciprocal of the broadened pulse duration.

$$B_T \leq 1/2\tau$$

Maximum bit rate  $B_T(\max) = 0.2/\sigma$  bit/s.

Maximum bandwidth  $B$  is one-half the maximum data rate.

$$B_T(\max) = 2B$$

## Intramodal dispersion: (chromatic)

→ It occurs in all types of fiber & results from the finite spectral line-width of the optical source. Optical sources don't emit single frequency but band of frequencies, there is propagation delay differences between different



spectral components of transmitted signal. This causes broadening of each transmitted mode.

Delay difference caused by dispersive properties of waveguide material (material dispersion), guidance effects within fiber structure (waveguide dispersion).

### Material dispersion:

Pulse broadening occurs when phase velocity of plane wave propagating in the dielectric medium varies non linearly with wavelength, material exhibits dispersion.

The pulse spreading due to material dispersion is by group delay  $\tau_g$  in optical fiber which is reciprocal of group velocity  $v_g$ .

$$\tau_g = d\beta/d\omega = \frac{1}{c} \left( n_1 - \lambda \frac{dn_1}{d\lambda} \right)$$

Pulse delay  $\tau_m$  due to material dispersion, in fiber length  $L$  is

$$\tau_m = \frac{L}{c} \left( n_1 - \lambda \frac{dn_1}{d\lambda} \right)$$

For a source with RMS spectral width  $\sigma_\lambda$ , mean wavelength  $\lambda$ , RMS pulse broadening due to material dispersion  $\sigma_m$  in Taylor series,

$$\sigma_m = \sigma_\lambda \frac{d\tau_m}{d\lambda} + \sigma_\lambda^2 \frac{d^2\tau_m}{d\lambda^2} + \dots$$

$$\sigma_m \approx \sigma_\lambda \frac{d\tau_m}{d\lambda}$$



$$\frac{dT_m}{d\lambda} = \frac{L}{c} \left[ \frac{dn_1}{d\lambda} - \lambda \frac{d^2 n_1}{d\lambda^2} - \frac{dn_1}{d\lambda} \right]$$

$$= -\frac{L\lambda}{c} \frac{d^2 n_1}{d\lambda^2}$$

RMS pulse broadening due to material dispersion is

$$\sigma_m = \frac{\sigma_\lambda L}{c} \left| \lambda \frac{d^2 n_1}{d\lambda^2} \right|$$

Material dispersion factor  $M = \frac{1}{L} \frac{dT_m}{d\lambda}$

$$M = \frac{1}{c} \left| \frac{d^2 n_1}{d\lambda^2} \right| \text{ ps km}^{-1} \text{ nm}^{-1}$$

### Waveguide Dispersion:

- \* Waveguiding creates chromatic dispersion. This results from varying in group velocity with wavelength for particular mode.
- \* Angle between ray & fiber axis varying with wavelength leads to variation in transmission times for rays - dispersion.
- \* Caused by index difference between core & cladding.

Normalized propagation constant

$$b = 1 - (\mu a / v)^2 = (\beta^2 / k^2 - n_2^2) / (n_1^2 - n_2^2)$$

$$\text{Group delay } \tau_{wg} = \frac{L}{c} \left[ n_2 + n_2 \Delta \frac{d(kb)}{dk} \right]$$

Normalized frequency  $v = ka \sqrt{n_1^2 - n_2^2}$

$$\tau_{wg} = \frac{L}{c} \left[ n_2 + n_2 \Delta \frac{dv_b}{dv} \right]; \quad \frac{dv_b}{dv} \text{ is waveguide dispersion.}$$



Intermodal dispersion:

It results from propagation delay difference between modes within multimode fiber cause pulse broadening.

When group velocity of different mode varies due to variation in group delay for each individual mode at a single frequency, this dispersion arises.

Multimode Stepindex fiber:

Fastest & slowest modes (axial ray & meridional ray) travels in fiber core. Delay difference between rays allows estimation of pulse broadening results in intermodal dispersion within fiber.

Time taken for axial ray to travel along a fiber length L gives min. delay time

$$T_{min} = \text{dist.} / \text{velocity} = \frac{L}{c/n_1} = n_1 \frac{L}{c}$$

Meridional ray exhibits max. delay time

$$T_{max} = \frac{L \cos \theta}{c/n_1} = \frac{Ln_1}{c \cos \theta}$$

$$\sin \phi_c = n_2/n_1 = \cos \theta$$

$$T_{max} = \frac{Ln_1}{c(n_2/n_1)} = \frac{Ln_1^2}{cn_2}$$

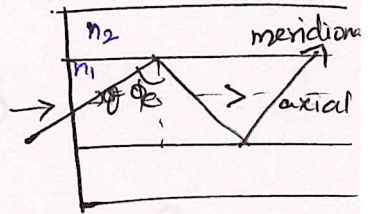

Delay difference between meridional ray & axial ray

$$\begin{aligned} \Delta T_s &= T_{max} - T_{min} = \frac{Ln_1^2}{cn_2} - \frac{Ln_1}{c} \\ &= \frac{Ln_1^2}{cn_2} \left( \frac{n_1 - n_2}{n_1} \right) \approx \frac{Ln_1^2 \Delta}{cn_2} \text{ when } \Delta \ll 1 \end{aligned}$$



After substituting,  $\Delta = (n_1 - n_2)/n_2$ , then

$$\delta T_s = L(NA)^2 / 2n_1 c$$

$$\text{Rms pulse broadening, } \sigma_s = \frac{Ln_1 \Delta}{2\sqrt{3}c} = \frac{L(NA)^2}{4\sqrt{3}n_1 c}$$

Multimode graded index fiber:

Intermodal dispersion in multimode is minimized by graded index. It has substantial bandwidth over step index.

Index profile:

$$n(r) = \begin{cases} n_1 (1 - 2\Delta(r/a)^2)^{1/2} & r < a \text{ (core)} \\ n_2 (1 - 2\Delta)^{1/2} = n_2 & r \geq a \text{ (cladding)} \end{cases}$$

Improvement in bandwidth achieved with refractive index profile highlighted by considering reduced delay difference between fast & slow modes  $\delta T_g$ .

$$\delta T_g = \frac{Ln_1 \Delta^2}{2c} = \frac{L(NA)^4}{8n_1^3 c}$$

EM theory gives width at fiber o/p is

$$\delta T_g = \frac{Ln_1 \Delta^2}{8c}$$

Rms pulse broadening of graded index compared with step index

$$\sigma_g = \frac{\Delta}{D} \sigma_s \quad D - \text{constant between 4 \& 10} \\ \text{depends on precise evaluation}$$



Overall dispersion :

It comprises both chromatic and intermodal terms. Total rms pulse broadening  $\sigma_T$  is

$$\sigma_T = (\sigma_c^2 + \sigma_n^2)^{1/2}$$

$\sigma_c$  - intramodal broadening

$\sigma_n$  - intermodal broadening

$\sigma_c$  consists of pulse broadening due to both material and waveguide dispersion.

Single mode Fibers:

Pulse broadening results from intra modal only. Bandwidth is limited by finite spectral width of source.

Transit time (group delay)  $\tau_g = \frac{1}{c} \frac{d\beta}{dk}$

First order dispersion parameter,  $D_T = d\tau_g/d\lambda$

Total Rms pulse broadening =  $\sigma_\lambda L \left| \frac{d\tau_g}{d\lambda} \right|$

$$= \frac{\sigma_\lambda L}{c\lambda^2} \frac{2\pi d^2\beta}{dk^2}$$

$\sigma_\lambda$  - Source Rms spectral line width.

Total first order dispersion  $D_T = D_m + D_w + D_p$

Where Material dispersion  $D_m = \frac{1}{c} \left| \frac{d^2n}{d\lambda^2} \right|$

Waveguide dispersion  $D_w = - \left( \frac{n_1 - n_2}{\lambda c} \right) \frac{d^2V_b}{dV^2}$

Profile dispersion  $D_p \propto \frac{d\Delta}{d\lambda}$



## Polarization:

Cylindrical fibers don't maintain polarization state of light i/p. Optical signal is detected by a photo diode which is insensitive to optical polarisation. These fibers are single mode and the maintenance of polarization state is fiber birefringence.

$$\beta_F = \frac{\beta_x - \beta_y}{2\pi/\lambda}$$

Characteristic length corresponds to propagation distance for which  $2\pi$  phase difference accumulate between modes is referred as beat length

$$L_B = \lambda / \beta_F = \frac{2\pi}{\beta_x - \beta_y}$$

## Polarisation Mode Dispersion (PMD):

- Source of pulse broadening which results from fiber birefringence, and it becomes a limiting factor for optical fiber communication at high transmission rates.

- It is a random effect due to both intrinsic & extrinsic factors which results in group velocity variation with polarisation state.



Differential group delay  $\Delta \tau = \delta \tau_g L$

Group delay difference between slow + fast modes over fiber lengths.

$$\delta \tau_g = \frac{\Delta \tau}{L} = \frac{d}{d\omega} (\beta_x - \beta_y)$$

$$= \frac{d}{d\omega} \left( \frac{\omega n_x}{c} - \frac{\omega n_y}{c} \right)$$

$$= \frac{d}{d\omega} \frac{\omega}{c} \Delta n_{eff} = \frac{\Delta n_{eff}}{c} - \frac{\omega}{c} \frac{d}{d\omega} \Delta n_{eff}$$

Where  $\delta \tau_g$  - DGD per unit length referred as PMD.

Dispersion Optimization of Single mode fibers:

Features of single mode fibers are,

- \* longer life
- \* low attenuation
- \* Good signal transfer quality
- \* Absence of modal noise
- \* Large BW-distance product.

Basic design-optimization includes,

- \* dispersion
- \* mode field diameter
- \* bending loss
- \* R-D profile
- \* cut off wavelength

Characteristics of Single mode fibers:

This includes index-profile configurations used to produce different fiber types, Concept of signal dispersion designs & calculations, MFD and signal loss due to fiber bending.



## R-I Profile (Refractive Index Profile):

When creating SM fibers, give attention to how fiber design affects both PMD & chromatic dispersion.

Dispersion of single mode fiber is lowest at 1300 nm while its attenuation is min. at 1550 nm.

To achieve max. transmission distance, dispersion null should be at wavelength of min. attenuation.

1300nm - Optimized Fibers:

- Used in Telecommunication networks.

Configurations:

1) Matched cladding fiber <sub>(MC)</sub> - Uniform refractive index throughout cladding. Typical diameter is  $9 \mu\text{m}$  &  $\Delta = 0.35\%$ .

2) Depressed cladding fiber <sub>(DC)</sub> - Innermost cladding has low refractive index than outer cladding. Typical diameter  $8.4 \mu\text{m}$ ,  $\Delta_1 = 0.25\%$ ,  $\Delta_2 = 0.12\%$ .  $\Delta_1, \Delta_2$  are positive & negative index differences.

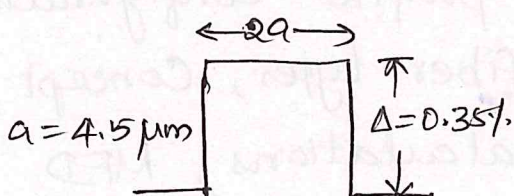

MC

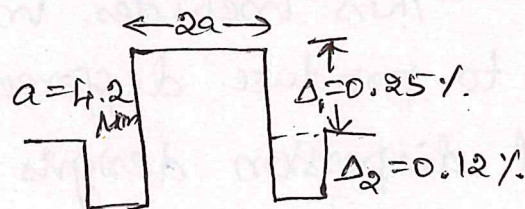

DC



Material dispersion depends on composition of the material.

Waveguide dispersion is a function of core radius, refractive index difference & shape of refractive index profile.

Dispersion Shifted fibers (DSF):

Addition of waveguide and material dispersion can shift the zero dispersion point of longer wavelength.

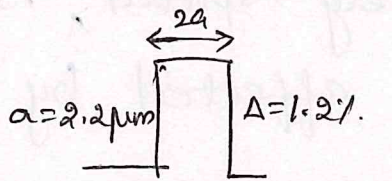

Step index DSF

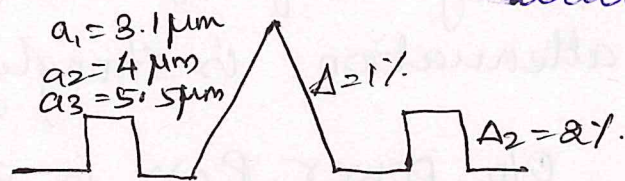

Triangular DSF

Zero dispersion value of DSF falls at 1550 nm, chromatic dispersion is -ve for  $\lambda < 1550$  nm, positive for longer wavelengths.

To reduce the effects of fiber nonlinearities, designers develop non-zero dispersion shifted fiber (NZDSF). These have a small amount of either all positive & all -ve dispersion.

Dispersion Flattening Approach - To distribute the dispersion min. over a wide spectral range.

These DSF are more complex to design.

It offers broader span of wavelengths to suit desired characteristics.



## Cut off wavelength:

Cut off wavelength of higher order mode  $LP_{11}$  is important parameter for SM because it separates SM from multimode regions.

$$\lambda_c = (2\pi a / v) \cdot (n_1^2 - n_2^2)^{1/2}$$

$v = 2.405 \rightarrow$  step index fiber.

At this wavelength, only  $LP_{01}$  mode should propagate. Cut-off region of  $LP_{11}$  is widely spread, since its attenuation is strongly affected by fiber bends.

O/p power  $P_1(\lambda)$  is measured over same wavelength range when a loop of small radius is included in test fiber to filter  $LP_{11}$  mode. Typical radius for this loop is 30mm.

Logarithmic ratio  $R(\lambda)$  between two transmitted powers  $P_1(\lambda)$  and  $P_2(\lambda)$  is

$$R(\lambda) = 10 \log [P_1(\lambda) / P_2(\lambda)]$$

Effective Cut off wavelength - largest wavelength at which higher order  $LP_{11}$  mode power relative to fundamental  $LP_{01}$  mode power is reduced to 0.1 db.



## Dispersion Calculations:

Total chromatic dispersion consists of material and waveguide dispersions. Resultant intramodal dispersion is  $D(\lambda) = \frac{d\tau}{d\lambda}$ ,  $\tau$  - group delay per unit length of fiber.

Broadening  $\sigma$  of an optical pulse over fiber length

$$\sigma = D(\lambda) L \sigma_s; \quad \sigma_s - \text{half power spectral width of source.}$$

\* For non-dispersion shifted fiber between 1270 nm to 1340 nm wavelength, dispersion is

$$D(\lambda) = \frac{\lambda}{4} S_0 \left[ 1 - \frac{\lambda_0}{\lambda} \right]^2.$$

where  $\lambda_0$  is zero dispersion wavelength.

$S_0$  is value at dispersion slope at  $\lambda_0$

\* For dispersion shifted fiber between 1500 nm to 1600 nm wavelength, the dispersion is

$$D(\lambda) = (\lambda - \lambda_0) S_0.$$

## Mode field diameter (MFD) & Spot Size:

Properties of fundamental mode are determined by radial extent of EM field including losses at launching & jointing, microbend loss, waveguide dispersion and width of radiation pattern.

MFD - Parameter for characterizing SM fiber properties. It's determined from mode field distribution



of fundamental fiber mode & is a function of  $d$ , core radius & RI profile of fiber.

For step & graded sm fibers operates near  $\lambda_c$ , field is approximated by gaussian distribution. MFD is taken as distance between opposite  $1/e = 0.37$  field amplitude points and power  $1/e^2 = 0.135$  points in relation to corresponding values on fiber axis

Spot size (mode field radius  $w_0$ ) is another parameter.  $MFD = 2w_0$ .  $w_0$  - nominal half width.

For many refractive index profile, MFD is larger than SM fiber core diameter.

For real fibers, and R-I profiles, radial field distribution is not strictly Gaussian, and hence alternative techniques have been proposed.

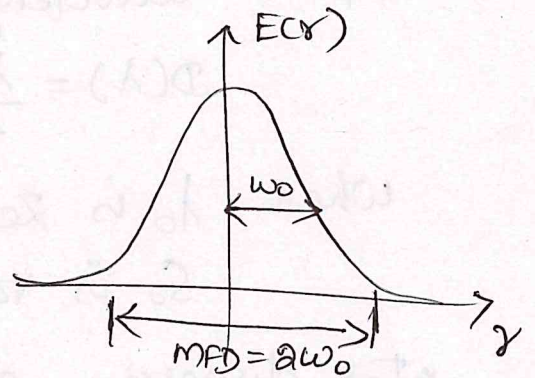



Problems:

- 1). When the mean optical power launched into an 8km length of fiber is 120μW, the mean optical power at the fiber output is 3μW. Determine:
- the overall signal attenuation or loss in db through fiber assuming there are no connectors or splices.
  - Signal attenuation per km for fiber.
  - Overall signal attenuation for 10km optical link using same fiber with splices at 1km intervals, each giving an attenuation of 1db;
  - the numerical input/output power ratio in (c).

Solution:

a) Overall signal attenuation in db is

$$= 10 \log_{10} (P_i/P_o) = 10 \log_{10} (120/3)$$

$$= 10 \log_{10} (40) = 16 \text{ db}$$

b) Signal attenuation per km for the fiber maybe obtained by dividing the result in (a) by fiber length

$$\alpha_{\text{db}} L = 16 \text{ db} \quad \therefore \alpha_{\text{db}} = 2 \text{ db/km}$$

c) As  $\alpha_{\text{db}} = 2 \text{ db/km}$ , loss incurred along 10km of fiber is

$$\alpha_{\text{db}} L = 2 \times 10 = 20 \text{ db}$$

The link has 9 splices (at 1km intervals) with attenuation of 1db, loss due to splices is 9db.

$\therefore$  Overall attenuation is  $20 + 9 = 29 \text{ db}$

d) Input/output ratio  $P_i/P_o = 10^{29/10} = 794.3$



2) A long single-mode optical fiber has an attenuation of  $0.5 \text{ dB/km}$  when operating at a wavelength of  $1.3 \mu\text{m}$ . The fiber core diameter is  $6 \mu\text{m}$  and laser source bandwidth is  $600 \text{ MHz}$ . Compare threshold optical powers for stimulated Brillouin and Raman scattering within the fiber at the wavelength specified.

Threshold optical power for SBS:

$$P_B = 4.4 \times 10^{-3} d^2 \lambda^2 \alpha_{\text{dBV}}$$

$$= 4.4 \times 10^{-3} \times 6^2 \times 1.3^2 \times 0.5 \times 0.6 = 80.3 \text{ mW}$$

Threshold optical power for SRS:

$$P_R = 5.9 \times 10^{-2} d^2 \lambda \alpha_{\text{dB}}$$

$$= 5.9 \times 10^{-2} \times 6^2 \times 1.3 \times 0.5 = 1.38 \text{ W}$$

3) A multimode graded index fiber exhibits total pulse broadening of  $0.1 \mu\text{s}$  over a distance of  $15 \text{ km}$ . Estimate: a) the max. possible bandwidth on the link assuming no intersymbol ~~sys~~ interference. b) pulse dispersion per unit length. c) BW-length product of fiber.

a) Max. possible optical BW = max. possible bit rate  
Assume no ISI.  $B_{\text{opt}} = B_T = 1/2\tau = 1/0.2 \times 10^{-6} = 5 \text{ MHz}$ .

b) Dispersion per unit length is acquired by dividing total dispersion by total length of fiber:

$$\text{Dispersion} = 0.1 \times 10^{-6} / 15 = 6.67 \text{ ns/km}$$

c) BW-length product =  $B_{\text{opt}} \times L$   
 $= 5 \times 10^6 \times 15 \times 10^3 = 75 \times 10^9 \text{ Hz}\cdot\text{m}$   
 $= 75 \text{ MHz}\cdot\text{km}$



4) A glass fiber exhibits material dispersion given by  $|\lambda^2 (d^2n_1/d\lambda^2)|$  of 0.025. Determine material dispersion parameter at a wavelength of  $0.85 \mu\text{m}$ .

$$M = \frac{1}{c} \left| \frac{d^2n_1}{d\lambda^2} \right| = \frac{1}{c\lambda} \left| \lambda^2 \frac{d^2n_1}{d\lambda^2} \right|$$

$$= \frac{0.025}{2.998 \times 10^5 \times 850} \text{ s nm}^{-1} / \text{km}$$

Material dispersion parameter  $M = 98.1 \text{ ps nm}^{-1} / \text{km}$ .

5) Find the radius of curvature at which the no. of modes (in a bent fiber) decreases by 50% in a graded index fiber.  $\alpha = 2$ ,  $n_1 = 1.5$ ,  $\Delta = 0.01$ ,  $a = 25 \mu\text{m}$  and  $\lambda = 1.3 \mu\text{m}$ .

$$M = \frac{1}{2} \left[ \frac{\pi a}{\lambda} \cdot NA \right]^2$$

$$\frac{1}{2} = \frac{1}{2} \left[ \frac{\pi \times 25}{1.3} \times NA \right]^2$$

$\therefore NA = 0.0165$

Radius of curvature  $R_c = \frac{3n_1^2 \lambda}{4\pi (NA)^3}$

$$= \frac{3 \times 1.5^2 \times 1.3}{4\pi \times (0.0165)^3} = \frac{8.775}{0.057} = 153.94 \mu\text{m}$$

6) A  $8 \mu\text{m}$  core diameter single mode fiber with a core refractive index of 2 & relative refractive index difference of 0.3% and operating wavelength of  $1.55 \mu\text{m}$ . Determine critical radius of curvature.

Given:  $\phi = 8 \mu\text{m}$ ,  $n_1 = 2$ ,  $\Delta = 0.3\%$ ,  $\lambda = 1.55 \mu\text{m}$

Relative index difference  $\Delta = \frac{n_1^2 - n_2^2}{2n_1^2}$



$$n_2^2 = n_1^2 - 2\Delta n_1^2$$

$$n_2 = \sqrt{2^2 - 2 \times 0.3 \times 0.2^2} = 1.99$$

Since,  $D = 8 \quad \therefore a = 4 \mu\text{m}$

Cut off wavelength of single mode fiber is

$$\lambda_c = \frac{2\pi a n_1 (2\Delta)^{1/2}}{V_c}$$

For single mode fiber  $V_c = 2.405$

$$\lambda_c = \frac{2\pi \times 4 \times 10^{-6} \times 2 (2 \times 0.03)^{1/2}}{2.405} = 3.9 \mu\text{m}$$

Critical radius of curvature for single mode fiber

$$R_{cs} = \frac{20\lambda}{\sqrt{n_1 - n_2}} \left( 2.748 - 0.996 \frac{\lambda}{\lambda_c} \right)^{-3}$$

$$= \frac{20 \times 1.55 \times 10^{-6}}{(2 - 1.99)^{3/2}} \left[ 2.748 - 0.996 \times \frac{1.55 \times 10^{-6}}{3.9 \times 10^{-6}} \right]^{-3}$$

$$= 2.3 \text{ nm}$$

7) A manufacturer's data sheet lists the material dispersion  $D_{mat}$  of  $\text{GeO}_2$  doped fiber to be  $110 \text{ ps/nm-km}$  at a wavelength of  $860 \text{ nm}$ . Find rms pulse broadening per km due to material dispersion if optical source is GaAlAs LED that has spectral width  $\sigma_\lambda = 40 \text{ nm}$  at an off wave length of  $860 \text{ nm}$ .

$$\sigma_\lambda = 40 \text{ nm}, L = 1 \text{ km}, D_{mat} = 110 \text{ ps/nm-km}$$

Rms pulse broadening due to material dispersion per km is

$$\sigma_m = \sigma_\lambda \times L \times D_{mat}$$

$$= 40 \times 1 \times 110 \times 10^{-12} = 4.4 \text{ ns/km}$$



8) An LED operating at 850 nm has a spectral width of 45 nm. What is the pulse spreading in ns/km due to material dispersion? Dec-12

$$\lambda = 850 \text{ nm}, \quad \sigma = 45 \text{ nm}.$$

RMS pulse broadening due to material dispersion is

$$\sigma_m = \sigma L M \quad ; \quad L = 1 \text{ m}.$$

$$\text{Material dispersion Constant } D_{\text{mat}} = -\frac{\lambda}{c} \cdot \frac{d^2 n}{d\lambda^2}$$

For LED source operating at 850 nm,  $\left| \lambda^2 \frac{d^2 n}{d\lambda^2} \right| = 0.025$

$$M = \frac{1}{c\lambda} \left| \lambda^2 \frac{d^2 n}{d\lambda^2} \right| = \frac{1}{(3 \times 10^8) 850} \times 0.025 = 9.8 \text{ ps/nm/km}$$

$$\sigma_m = 45 \times 1 \times 9.8 = 441 \text{ ps/km}$$







## UNIT III . OPTICAL SOURCES AND DETECTORS .

### Introduction:

Optical source - Active component - Used to convert electrical energy into optical energy.

- Types:
- 1) Wideband continuous spectra source (Incandescent lamp)
  - 2) Monochromatic incoherent source (LED)
  - 3) Monochromatic coherent source (LASER)

### Intrinsic and Extrinsic Material:

Intrinsic material - A perfect material contains no impurities. Due to thermal vibrations of crystal atoms, some electrons in valence band gain energy to excite into conduction band, thereby it produces free electron hole pairs because electron moves to conduction band leaves a hole.

$\therefore$  Intrinsic carrier density = no. of holes = no. of e's  
 $n = p = n_i$

Extrinsic material - Impurities are added to pure semiconductor. Increase in one type reduces no. of carriers in other type. The product of two types of carriers remains constant at given temperature. This gives to mass action law  $\boxed{np = n_i^2}$  which is valid for both intrinsic & extrinsic at thermal equilibrium.

### Types of Carriers:

1. Majority carriers - (electrons in n-type, holes in p-type)
2. Minority carriers - (holes in n-type, electrons in p-type)



## Direct and Indirect bandgaps:

Semiconductors are classified as direct and indirect bandgap materials depend on shape of bandgap as a function of momentum.

Consider recombination of an electron and hole accompanied by emission of photon. In recombination, electron and hole have same momentum - direct bandgap.

Conduction band minimum, valence band maximum energy levels occur at different values of momentum - Indirect bandgap.

## Light Emitting Diode (LED):

- Incoherent optical source
- Operate at low current density
- wider spectral linewidth
- linewidth corresponds to range of photon energy between 1 and  $3.5 kT$ .
- Used as multimode source

## Advantages:

- \* Simple fabrication
- \* Low cost
- \* Less temperature dependence
- \* Simple drive circuit
- \* High linearity & reliability

## Drawbacks:

- \* Harmonic distortion
- \* Low modulation bandwidth
- \* Low optical power coupled to fiber.



# Quantum Efficiency and LED Power:

Internal quantum efficiency ( $\eta_{int}$ ) - Ratio of the radiative recombination rate to total recombination rate.

$$\eta_{int} = \frac{R_r}{R_r + R_{nr}} ; \quad \begin{array}{l} R_r - \text{Radiative recombination rate} \\ R_{nr} - \text{non-radiative recombination rate} \end{array}$$

$$\tau_r = n/R_r, \quad \tau_{nr} = \frac{n}{R_{nr}} ; \quad \begin{array}{l} \tau_r - \text{radiative lifetime} \\ \tau_{nr} - \text{non radiative lifetime} \end{array}$$

$$\therefore \eta_{int} = \frac{1}{1 + \frac{R_{nr}}{R_r}} = \frac{1}{1 + \frac{\tau_r}{\tau_{nr}}} \quad \text{where } \frac{1}{\tau} = \frac{1}{\tau_r} + \frac{1}{\tau_{nr}}$$

If current injected into LED is  $I$ ,  $q$ -electron charge, then total recombination per sec. is

$$R_r = R_{nr} = I/q ;$$

$$\tau_{int} = \frac{R_r}{I/q}$$

Optical Power  $P_{int} = \eta_{int} (I/q) h\nu$  where  $h\nu$  - photon energy

External quantum efficiency - Ratio of photons emitted from LED to no. of photons generated internally.

$$\eta_{ext} = \frac{1}{n(n+1)^2}$$

Optical power emitted from LED is

$$P = \eta_{ext} \cdot P_{int} = \frac{1}{n(n+1)^2} P_{int}$$

## LED Structures:

- \* Homo junction - PN diode formed by adjoining p & n in single crystal
- \* Hetro junction - Interface between two adjoining single crystal semiconductors with diff. bandgap



Hetero junctions are classified as isotype, anisotype.

Isotype hetero junction - Reduces carrier diffusion length, provides transparent layer close to active region, which reduces absorption of light from the structure.

Anisotype - Large bandgap differences improve injection efficiency of electrons and holes.

Double hetero junction - formed by two different semi-conductors on each side of active region.

Types of LED Structures:

- \* Surface emitter
- \* Superluminescent
- \* Planar LED
- \* Edge emitter
- \* Resonant cavity
- \* Dome LED.

Surface Emitter LED:

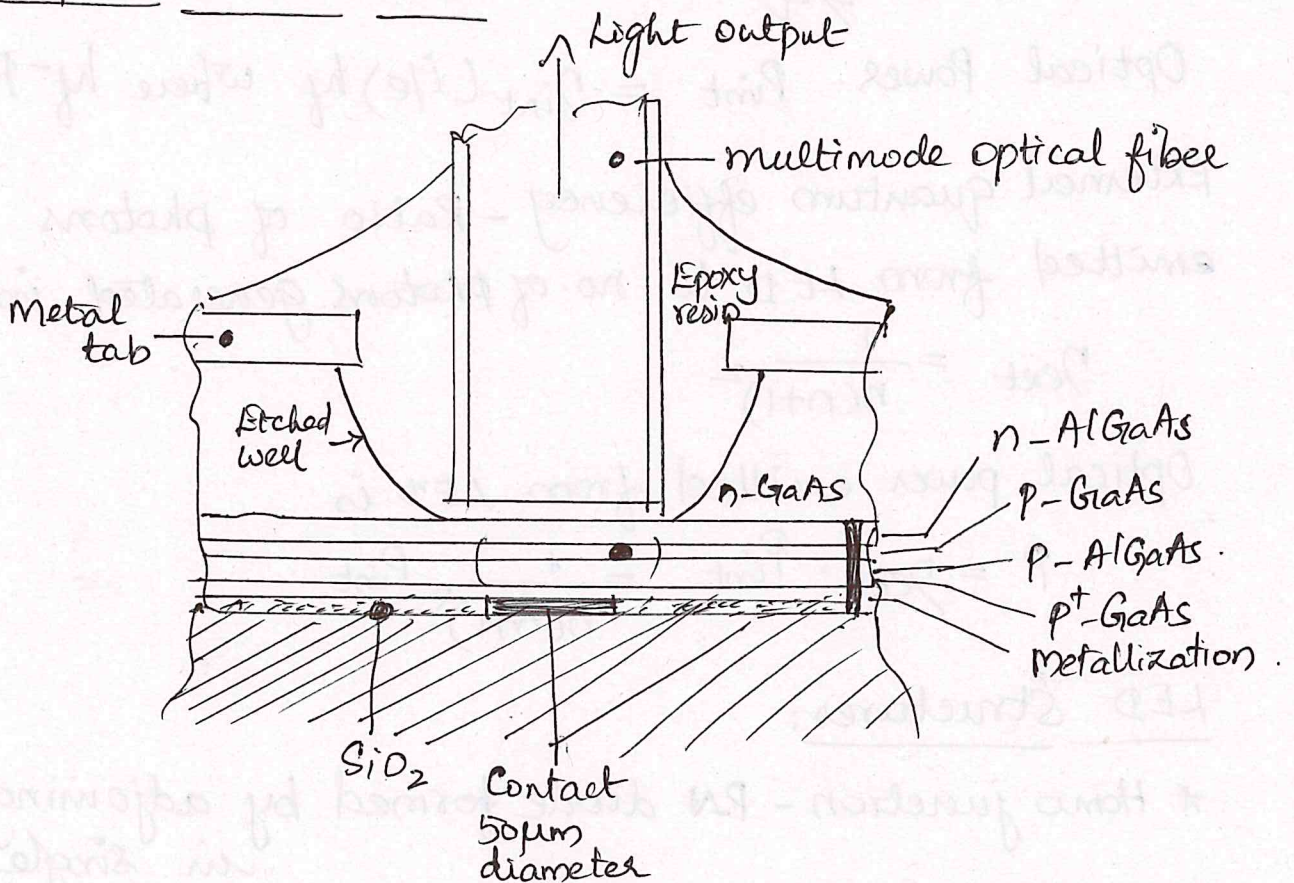

Structure of an AlGaAs DH surface-emitting LED (Burros type).



A method for obtaining high radiance is to restrict the emission to small active region within the device. This structures have low thermal impedance in the active region allows high current density & high radiation emission.

In this structure, internal absorption is low due to large bandgap, reflection coefficient is high to give high radiance. The emission from active layer is isotropic (i.e) Lambertian with beam width  $120^\circ$ .

Power coupled to multimode step index fiber is

$$P_c = \pi (1-r) A R D (NA)^2$$

where  $r$  is Fresnel reflection coefficient.

$A$  is core cross-section area

$RD$  is radiation of source.

For graded index, source diameter be one-half of fiber core diameter. In both, lens coupling provides increased power level.

This structure allows lateral current spreading, for contact diameters less than  $25 \mu m$ . This spreading results in reduced current density.

A technique used to reduce current spreading is to fabricate mesa structure SLED. Mesas with  $20$  to  $25 \mu m$  diameter at active layer formed by chemical etching. This InP devices emit  $1.3 \mu m$  & had integral lens to improve coupling efficiency. Monolithic lens structure improve power coupled into fiber from LED.



## Edge Emitter LED:

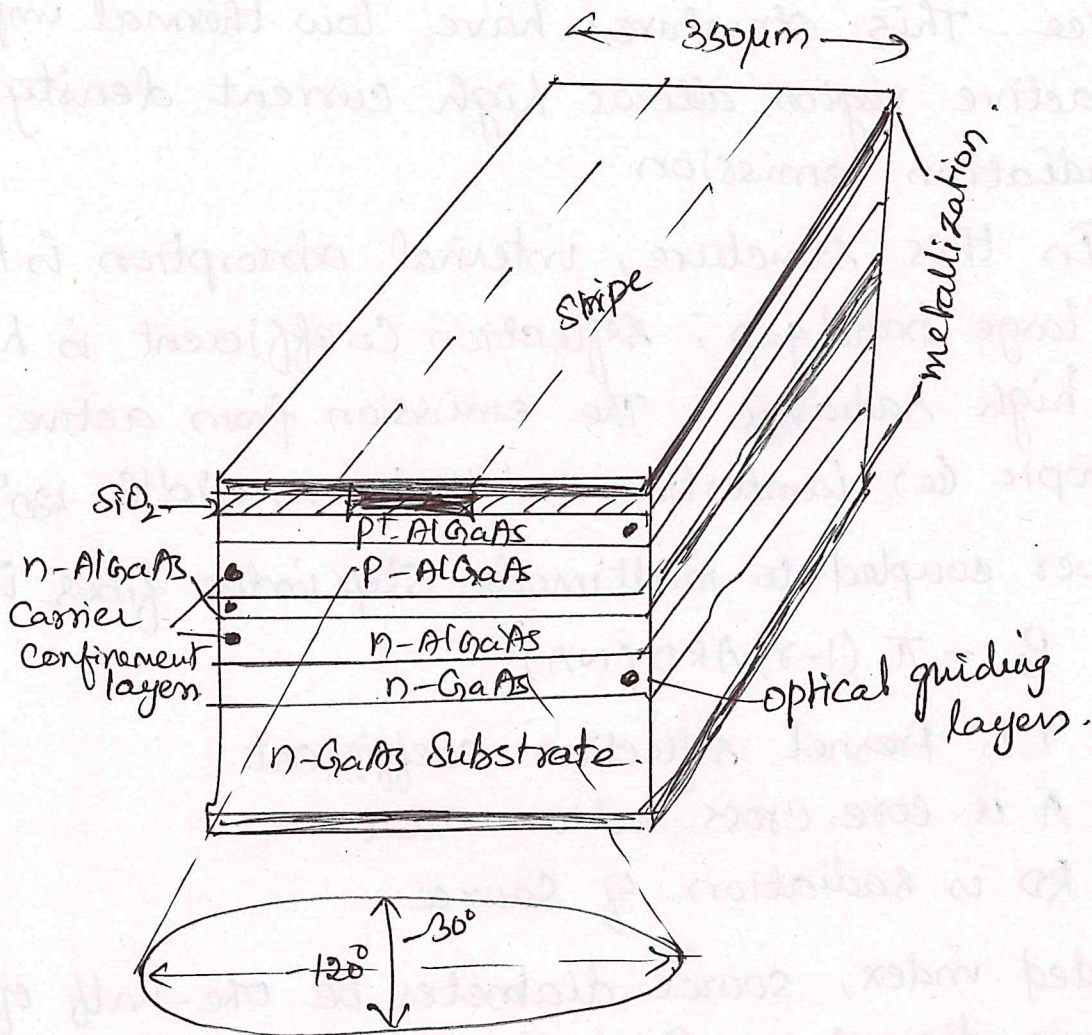

This stripe geometry DH edge emitter LED takes advantage of transparent guiding layers with a very thin active layer in order that the light produced in the active layer spreads into transparent guiding layers, reducing self absorption in active layer.

Most of the light is emitted at one end face only due to reflector on the other end face & anti reflection coating on emitting end face. The effective radiance is high gives increased coupling efficiency.



The ELED comprises a mesa structure. Tilted back facet of the device was formed by chemical etching to suppress laser oscillation.

Active layer is heavily doped with Zn to reduce minority carrier lifetime, improve the device modulation bandwidth. When operating at 600 mbits speed, lens coupling launch average power  $4 \mu\text{W}$  at peak drive current  $100 \text{ mA}$ . Current increases, coupled power also increases slightly.

Advanced InGaAsP ELED was fabricated as a V-grooved substrate. The front facet was antireflection coated & rear facet was etched at a slant to prevent laser action.

### Light Source Materials:

Direct band gap material is used for active layer of an optical source. It provides radiative recombination at high level to produce optical emission.

Although none of single element semiconductors are direct band gap. These compounds III-V materials used.

For operation in 800 to 900 nm, ternary alloy  $\text{Ga}_{1-x}\text{Al}_x\text{As}$  is used. The ratio  $x$  of AlAs to GaAs determines band gap of alloy & wavelength of peak emitted radiation.



Emission Spectrum of  $Ga_{1-x}Al_xAs$  is shown in fig

Width of spectral pattern at its half power point is Full width Half Maximum (FWHM) Spectral width.

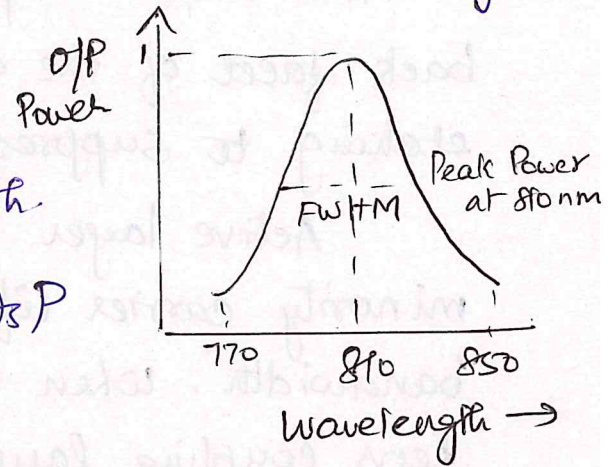

The alloys  $GaAlAs$  &  $InGaAsP$  are chosen as light sources.

At long wavelength, quaternary alloy  $In_{1-x}Ga_xAs_yP_{1-y}$  is preferred.

Relation between energy  $E$  & frequency  $\nu$ ,

$$E = h\nu = hc/\lambda$$

$$\lambda = 1.24 / E_g(\text{eV}) \text{ in the form } \mu\text{m}$$

Band gap is found by measuring energy required to excite electrons from valence band to conduction band.

### Modulation of LED:

Response time of an optical source dictates how fast an electrical input drive signal varies the light output level. The following factors determine the response time:

- \* doping level in the active region
- \* injected carrier lifetime  $\tau_i$  in the recombination region
- \* parasitic capacitance of LED.

$$\text{Optical output power } P(\omega) = P_0 [1 + (\omega\tau_i)^2]^{-1/2}$$

$P_0$  - Power emitted at zero modulation frequency



Modulation bandwidth - The electrical signal power  $P(\omega)$  has dropped to half its constant value results from modulation portion of optical signal. This is electrical 3 db point.

Ratio of output electrical power at the frequency to the power at zero modulation is

$$\text{Ratio (elect.)} = 10 \log [P(\omega) / P(0)] = 10 \log [I^2(\omega) / I^2(0)]$$

where  $I(\omega)$  - electrical current in the detector circuit.

Modulation bandwidth in terms of optical term is 3 db bandwidth determined from the ratio of optical power to the unmodulated value of the optical power. Since, detected current is directly proportional to the optical power.

$$\text{Ratio (opt.)} = 10 \log [P(\omega) / P(0)] = 10 \log [I(\omega) / I(0)]$$

### LASER diode:

LASER - Light Amplification by Stimulated Emission of Radiation.

Basic Concepts: Absorption, emission of radiation.

The interaction of light with matter takes place in discrete packets of energy or quanta called photons.

Absorbed or emitted radiation is related to energy difference  $E = E_2 - E_1 = hf$ .

When a photon with energy is incident on atom, it is excited into higher state  $\rightarrow$  Absorption.

When atom is initially at high state, transferred to lower state  $\rightarrow$  emission of photon.



Emission process occurs in two ways:

- a) Spontaneous emission - in which atoms return to lower energy state in random manner.
- b) Stimulated emission - when photon energy equal to  $E_2 - E_1$  interacts with the atom cause it to return to lower state with a creation of second photon.

Population Inversion:

Under thermal equilibrium, low energy level  $E_1$  contains more atoms than upper energy level. To achieve optical amplification, it is necessary to create non equilibrium distribution of atoms (i.e) Upper energy level is more than lower. That is population inversion.

Types: Homo junction, Hetero junction - isotype, anisotype.

External Quantum efficiency  $\eta_D$ :

- Ratio of increase in photon output rate for a given increase in the no. of injected electrons.

$$\eta_D = dP_e / dI(E_g) \quad \text{where } P_e - \text{Optical power emitted from device}$$

$E_g$  - Bandgap energy.

$\eta_D$  gives a measure of rate of change of optical output power with current. It defines slope of output characteristic in the lasing region for a device. It is slope quantum efficiency.



Internal quantum efficiency  $\eta_i$ :

$$\eta_i = \frac{\text{no. of photons produced in the laser activity}}{\text{no. of injected electrons}}$$

Total efficiency  $\eta_T = \frac{\text{total no. of opt photons}}{\text{total no. of injected electrons}}$

External power efficiency  $\eta_{ep} = \frac{P_e}{P} \times 100 = \frac{P_e}{IV} \times 100\%$   
 where  $P = IV$  is d.c. electrical input power.

So, total efficiency,  $\eta_{ep} = \eta_T (E_g/v) \times 100\%$

Injection Laser diode structures & radiation patterns:

1. Gain guided lasers:

Fabrication of multimode injection lasers with single or small no. of lateral modes is achieved by use of stripe geometry. That is gain guided lasers.

DH region has an active region of GaAs bounded on both sides by AlGaAs regions. The current is confined by etching a narrow stripe in a SiO<sub>2</sub> film.

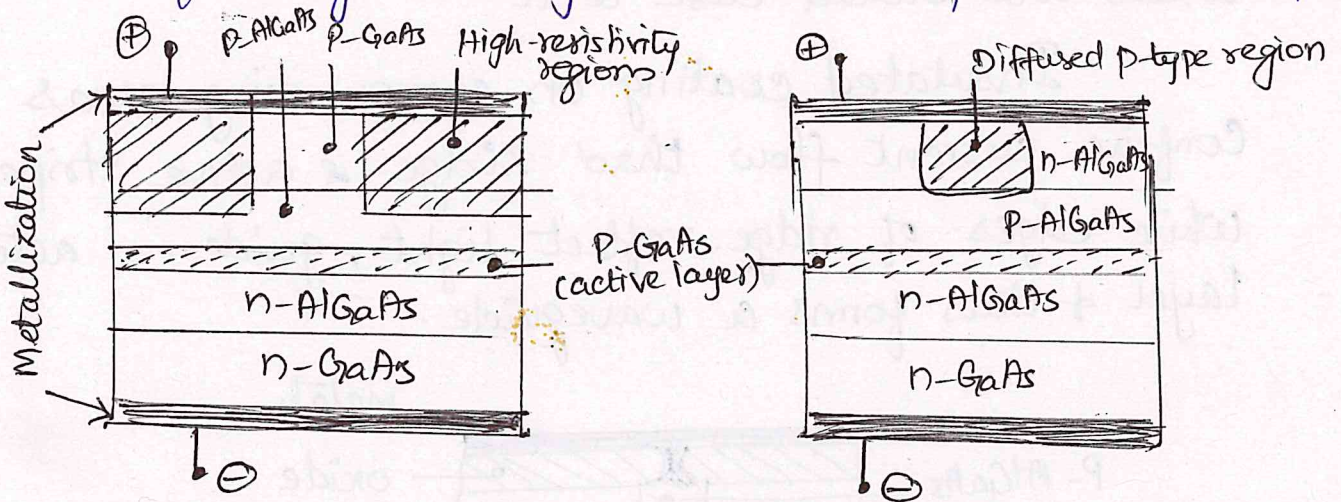

Proton-isolated stripe GaAs/AlGaAs laser

p-n junction isolated GaAs/AlGaAs laser.



Techniques for fabrication of gain guided lasers:

- \* In proton isolated, resistive region formed by proton bombardment gives better current confinement than simple oxide stripe & has thermal properties due to absence of  $\text{SiO}_2$  layer.
- \* P-n junction isolation involves a selective diffusion thro' n-type surface region in order to reach p-type layers.

Gain-guided lasers are available for operation in shorter wavelength (GaAs active regions) and longer wavelength range (InGaAsP active regions)

2) Index guided lasers:

These are fabricated to operate at various wavelengths. Active region thickness is varied by growing it over a channel/ridge in the substrate. Ridge is produced above active region & surrounding areas are etched close to it.

Insulated coating on surrounding areas confine current flow thro' ridge & active stripe while edges of ridge reflect light, guide in active layer & thus forms a waveguide.

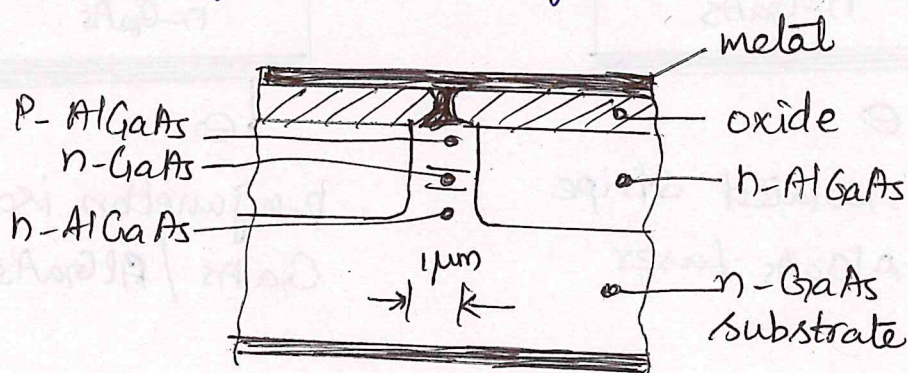



Optical field is confined in both transverse & lateral directions with good carrier confinement.

Higher bandgap, low refractive index confine material is AlGaAs for GaAs lasers operates in 0.8 to 0.9µm wavelength, InP in InGaAsP devices operate in 1.1 to 1.6µm wavelength range.

### 3) Quantum well lasers:

These are fabricated with very thin active layer with 10nm thickness. The carrier motion normal to the active layer is restricted, results in quantization of kinetic energy into discrete energy levels. This is similar to well-known quantum mechanical problem of 1-D potential well, so these are quantum well lasers.

They allow high gain at low carrier density, thus providing a possibility of lower threshold currents.

Both single quantum well (SQW) corresponds to single active region & multi quantum well corresponds to multiple active regions, lasers are utilized.

The layers separate active regions are called barrier layers.

### 4. Quantum-dot lasers:

Quantum well lasers have been developed in which device contains single discrete atomic structure called Quantum Dot (QD). QDs are small elements. QD - dot-in-a-well device.

QD is in nm/micron, fabricated by semiconductor crystalline materials.



QD has single electron to several thousand electrons. QD is zero dimensional. Single dimensional structure forms a quantum wire or dot.

QD laser has very low-threshold current density.

### Laser diode modes + Threshold Conditions:

For optical system, if greater than 200 MHz is needed, LED is preferred.

→ Laser diode has response time  $< 1$  ns,  
spectral width  $\approx$  nm.

→ Laser diodes are multilayered heterojunction devices.

### Fabry-Perot resonator cavity:

Two flat, partially reflecting mirrors are directed toward each other. The purpose of mirrors is to establish strong optical feedback in longitudinal direction.

This feedback converts device into oscillator.

The unused end can be coated with dielectric reflector to reduce optical loss in the cavity.

As light reflects back & forth, electric fields of light interfere successful round trips. The optical frequencies at which constructive interference occurs are resonant frequencies of the cavity.

Spontaneously emitted photons have wavelengths at resonant frequencies reinforce themselves, so optical field becomes very strong. Resonant wavelengths are called longitudinal modes because resonate along the length of cavity.



## Distributed Feedback Laser (DFB):

In this, lasing action is obtained by periodic variation of refractive index along longitudinal dimension of diode.

Full optical sp from front face. Dielectric reflector can be deposited on the rear face to reduce optical loss.

The optical radiation within resonant cavity of laser diode sets up a pattern of electric & magnetic field lines called modes of cavity.

\* Longitudinal modes - relates to length of cavity and determine structure of frequency spectrum.

\* Lateral modes - lie in the plane of pn junction. These modes depend on sidewall preparation & width of cavity.

\* Transverse modes are associated with EM field and in the direction perpendicular to plane of pn junction.

### Lasing conditions and resonant frequencies.

The EM wave propagates in longitudinal direction is

$$E(z, t) = I(z) e^{j(\omega t - \beta z)}$$

where  $I(z)$  is optical field intensity.

$\omega$  is optical radian frequency

$\beta$  is propagation constant

Fundamental expression for lasing in Fabry perot is

$$I(z) = I(0) e^{[\Gamma g(h\nu) - \alpha(h\nu)]z}$$

where  $\Gamma$  - optical field confinement factor.

$\alpha$  - effective absorption coefficient

$z$  - distance traverses along lasing cavity.



The condition of lasing threshold is

For amplitude :  $I(2L) = I(0)$  ; For phase  $e^{-j\beta L} = 1$

Optical gain at threshold = Total loss in the activity.

$$(ie) \tau_{gth} = \alpha L$$

Lasing expression is reduced to,

$$\sqrt{g_{th}} = \alpha + \frac{1}{2L} \ln\left(\frac{1}{R_1 R_2}\right) ;$$

$$\tau_{gth} = \alpha_L = \alpha + \alpha_{end}$$

where  $\alpha_{end}$  is mirror loss in lasing cavity.

Condition for lasing to occur is that gain  $g \geq g_{th}$  i.e. threshold gain.

### Rate Equations:

Relation between optical output power and diode drive current can be determined by rate equations.

The two rate equations for electron density  $n$  and photon density  $\phi$  are:

$$\frac{dn}{dt} = \frac{J}{ed} - \frac{n}{\tau_{sp}} - Cn\phi \quad m^{-3}s^{-1}$$

$$\frac{d\phi}{dt} = Cn\phi + \frac{\delta n}{\tau_{sp}} - \frac{\phi}{\tau_{ph}} \quad m^{-3}s^{-1}$$

where  $J$  - current density

$e$  - charge of  $e^-$

$d$  - thickness of recombination region

$\tau_{sp}$  - Spontaneous emission lifetime.

$C$  - Coefficient

$\delta$  - small fractional value

$\tau_{ph}$  - Photon life time.



Rate equations may be used to study both transient and steady-state behavior of the semiconductor laser.

→ Steady state is characterised by left hand side eqn is zero when  $n$  &  $\phi$  non zero.

→ For any  $\phi$ ,  $\frac{d\phi}{dt}$  will be positive when

$$Cn - \frac{1}{\tau_{ph}} \geq 0$$

→ Threshold value of ~~current~~ density  $n_{th} = \frac{1}{C\tau_{ph}}$

→ Threshold current density in the steady state,

$$\frac{J_{th}}{ed} = \frac{n_{th}}{\tau_{sp}}$$

→ The steady state photon density  $\phi_s$  is provided by substituting in 1st eqn,

$$0 = \frac{(J - J_{th})}{ed} - Cn_{th}\phi_s$$

$$\text{Rearranging, } \phi_s = \frac{1}{Cn_{th}} \frac{(J - J_{th})}{ed} = \frac{\tau_{ph}}{ed} (J - J_{th})$$

External quantum efficiency:

It is no. of photons emitted per electron hole pair recombination above threshold point.

$$\eta_{ext} = \frac{\eta_i (g_{th} - \alpha)}{g_{th}}$$

$\eta_i$  - Internal quantum efficiency

$g_{th}$  - Threshold gain

$\alpha$  - Absorption coefficient

$\eta_{ext}$  for std laser is 15-20%.



Resonant Frequencies :

At threshold lasing,  $2\beta L = 2\pi m$

$$m = 2L \cdot \frac{\nu}{\lambda} = 2L \frac{n\nu}{c}$$

Gain in any laser is a function of frequency. For Gaussian op, gain and frequency are

$$g(\lambda) = g(\lambda_0) e \left[ -\frac{(\lambda - \lambda_0)^2}{2\sigma^2} \right]$$

where  $g(\lambda_0)$  - max. gain

$\lambda_0$  - centre wavelength in spectrum.

$\sigma$  - Spectral width of gain

The frequency spacing between two successive modes is

$$\Delta \nu = \frac{c}{2Ln} \quad ; \quad \Delta \lambda = \frac{\lambda^2}{2Ln}$$

Comparison of LED & ILD :

- 1) In LED optical op is incoherent, but in laser it is coherent
- 2) In LED, no optical resonant cavity, In laser optical energy from optical resonant cavity
- 3) LED has no spatial and temporal coherence. LASER has spatial & temporal coherence
- 4) Op radiation of LED has broad spectral width, but in laser it is highly monochromatic.



## Single Mode Lasers:

- contain only a single longitudinal mode & a single transverse mode.
- For high speed long distance communications.
- narrow spectral width of the optical emission.

### \* Vertical-cavity surface emitting laser (VCSEL)

- has builtin frequency selective grating.
- Light emission is perpendicular to the Semiconductor surface.
- Integration of multiple lasers in single chip.
- Small active region leads to low threshold currents.
- Mirror system consists of semiconductor material such as Si/SiO<sub>2</sub>, as one material and an oxide layer such as Si/Al<sub>2</sub>O<sub>3</sub> as other material.

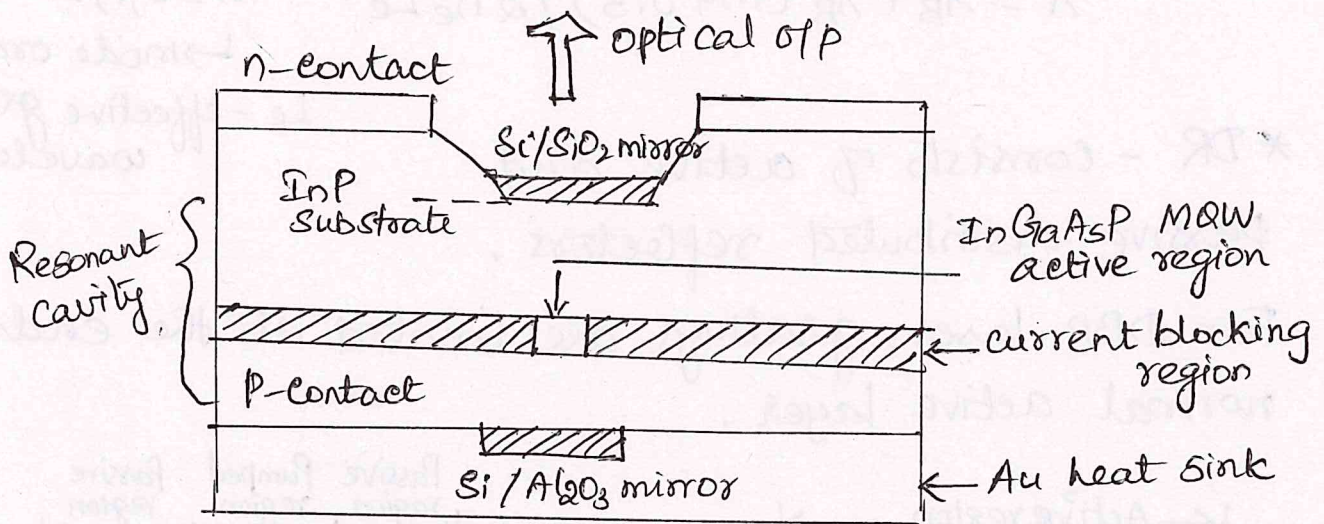

VCSEL Architecture.

### LASER configurations:

- 1) Distributed Bragg phase-grating Reflector (DBR)
- 2) Distributed Feedback laser (DFB)
- 3) Distributed Reflector (DR).



In all the above, frequency selective reflector is a corrugated grating that is passive waveguide layer adjacent to the active region.

\* DBR - A phase grating is varying refractive index that causes two counter propagating travelling waves to couple.

$$\text{Bragg wavelength } \lambda = 2 n_e A / k$$

$n_e$  - effective refractive index of the mode

$k$  - order of the grating.

\* DFB - Grating for wavelength selector is formed over the entire active region. In an ideal laser, the longitudinal modes are spaced symmetrically around at wavelengths given by,

$$\lambda = \lambda_B + \lambda_B^2 (m + 0.5) / 2 n_e L_e$$

$m = 0, 1, 2, \dots$

$\rightarrow$  mode order

$L_e$  - effective grating wavelength.

\* DR - consists of active and passive distributed reflectors.

For DBR laser, gratings are located at the ends of normal active layer.

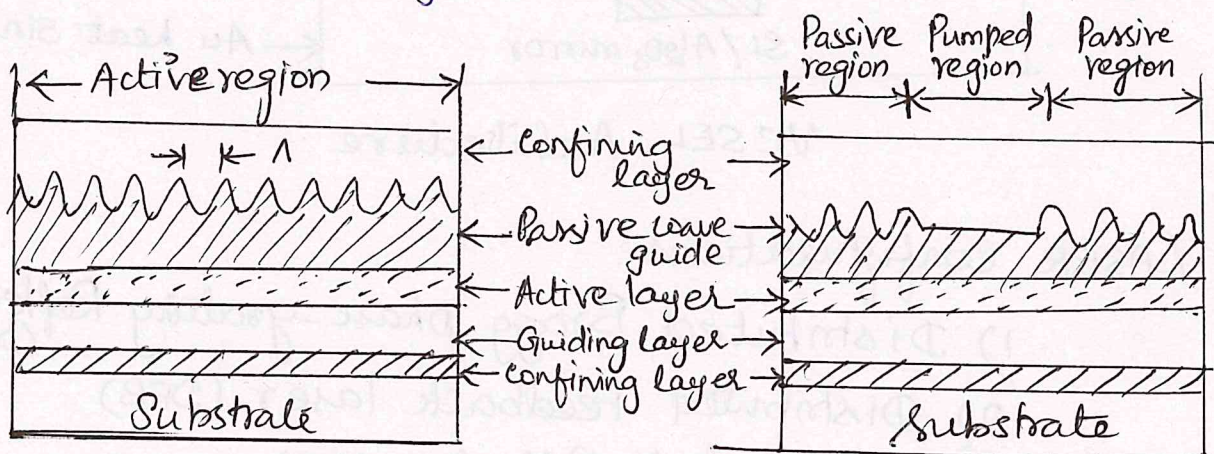

DFB

DBR



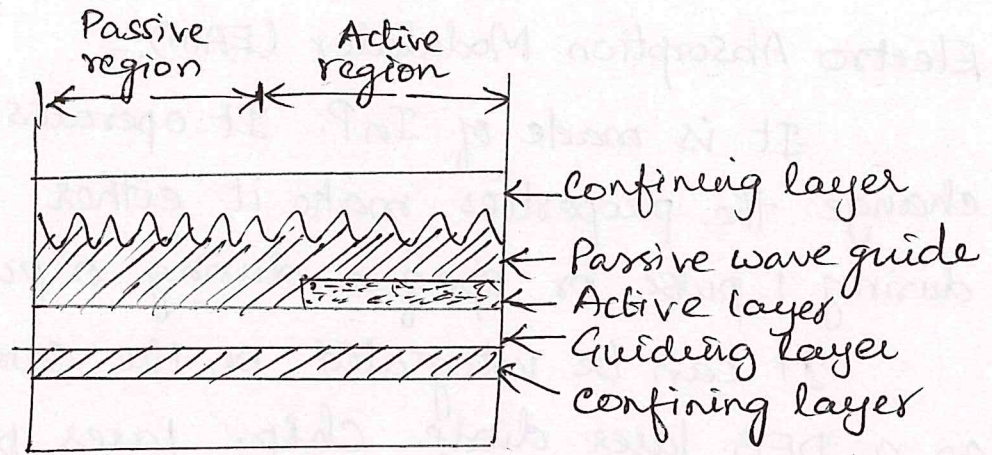

DBR

### External Modulation:

For high rate applications, external modulator is used. Optical source emits a const-amplitude light signal, which enters the external modulator. change the optical power level that exits the external modulator. This process produces a time-varying optical signal.

Electro-optical phase modulator - made of  $\text{LiNbO}_2$  Lithium Niobate. Light beam is split in half and sent thro' two separate paths. A high speed electric signal changes phase of light in one path.

When two halves of signal meet again at o/p, they will recombine either constructively or destructively.

The constructive recombination results bright signal corresponds to a 1 pulse.

Destructive recombination cancels two halves, so no signal at o/p. (ie) 0 pulse.



## Electro Absorption Modulator (EAM):-

It is made of InP. It operates by electric signal change the properties make it either transparent during 1 pulse or opaque during 0 pulse.

It can be integrated on the same substrate, as a DFB laser diode chip. Laser plus modulator put in a std package, to reduce drive voltage, power and space requirements.

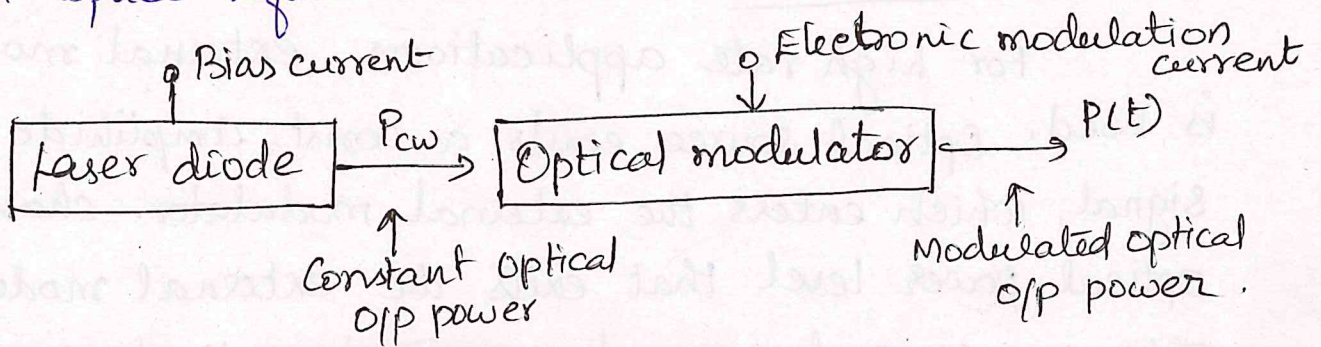

Generic external modulator.

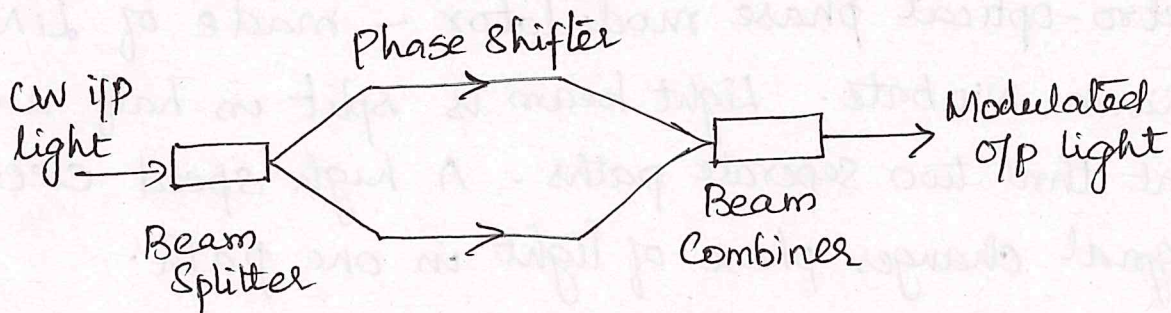

Operational Concept of EAM

## Temperature Effects:

An important factor to consider in the application of laser diodes is the temp. dependence of the threshold current. This increases with temperatures in all types of Semiconductor lasers. Temperature variation of  $I^{th}$  can be approximated by empirical expression

$$I^{th}(T) = I_2 \exp(T/T_0)$$

where  $T$  - measure of threshold temp. coefficient



The lasing threshold can change as laser ages. If a constant optical o/p power level is to be maintained as the temp. of laser changes, it is necessary to adjust the dc bias current level. One possible method for achieving this is an optical feedback scheme.

Optical feedback can be carried out by using a photo detector to sense the variation in optical power emitted from rear facet of the laser and monitor a small portion of the fiber-coupled power emitted from the front facet.

The photo detector compares the optical power o/p with reference level & adjusts dc-bias current level to maintain a constant peak light o/p. For operation in the 800 to 900 nm region, silicon pin photodiode exhibits these characteristics.

Optical detectors:

→ Converts the received optical signal into an electrical signal. Improvement of detector characteristics and performance thus allows the installation of fewer repeater stations and lowers both the capital investment and maintenance costs.

Requirements for detectors:

1. High sensitivity at the operating wavelengths.
2. High fidelity.
3. Large electrical response to the received optical signal.



4. Short response time to obtain a suitable bandwidth.
5. A min. noise introduced by the detector
6. Stability of performance characteristics
7. Small size
8. Low bias voltages
9. High reliability
10. Low cost.

**PIN photo diode:** In order to allow operation at longer wavelengths where the light penetrates more deeply into semiconductor material, wider depletion region is necessary. To achieve this, n-type is doped lightly that can be considered intrinsic, and to make a low resistance contact a highly doped n-type layer is added. This creates p-i-n structure.

**Construction:**

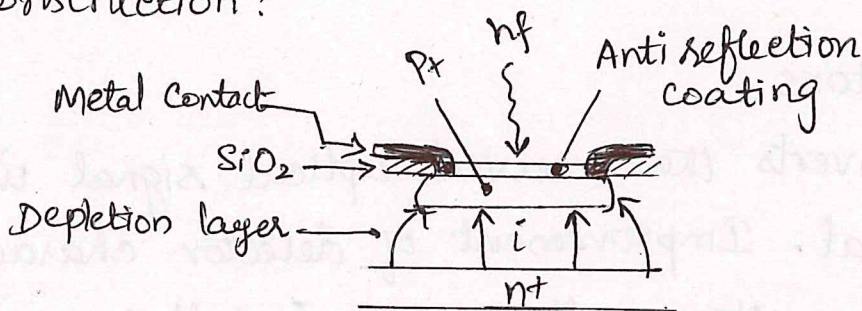

Structure of front-illuminated Silicon PIN photo diode.

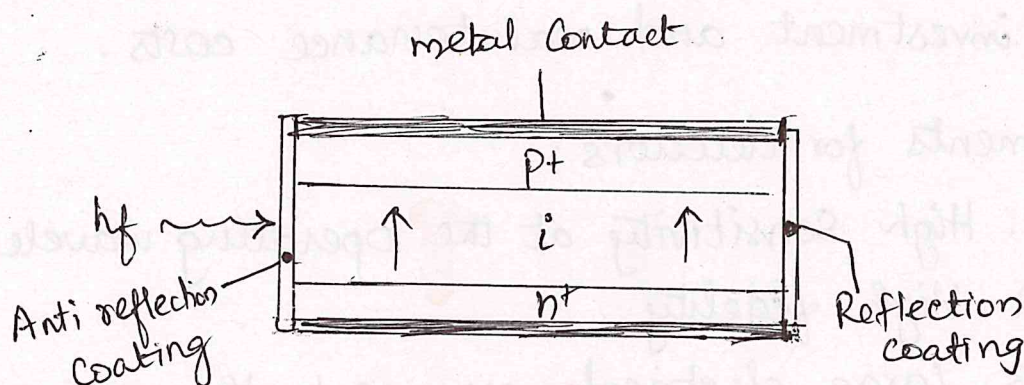

Structure of side-illuminated PIN photo diode.



The front-illuminated photo diode, when operating in 0.8 to 0.9  $\mu\text{m}$  band requires a depletion region of between 20 & 50  $\mu\text{m}$  in order to attain high quantum efficiency together with fast response ( $< \text{ns}$ ) and low dark current ( $1 \text{ nA}$ ).

The side-illuminated structure, where light is injected parallel to the junction plane, exhibits large absorption width.

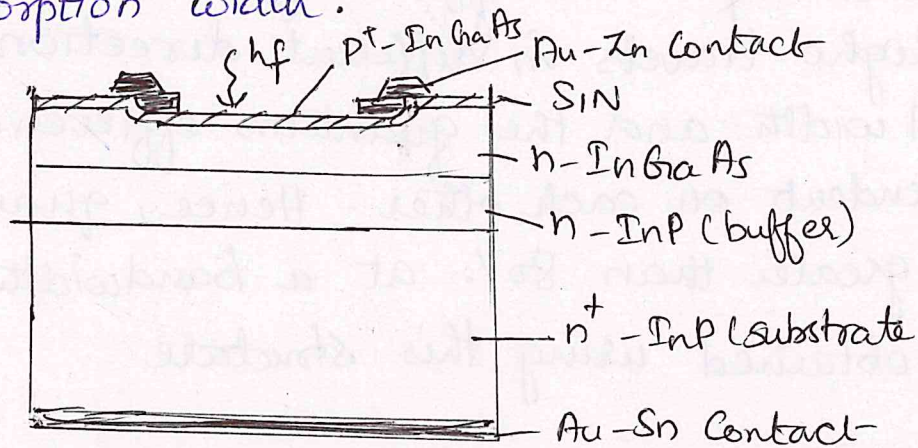

Planar InGaAs PIN photodiode.

This planar structure requires epitaxial growth of several layers on an n-type InP substrate. The incident light is absorbed in the low-doped n-type InGaAs layer generating carriers. The discontinuity due to homo junction between n<sup>+</sup> InP substrate & n-InGaAs absorption region maybe noted. This can be reduced by the incorporation of n-type InP buffer layer.

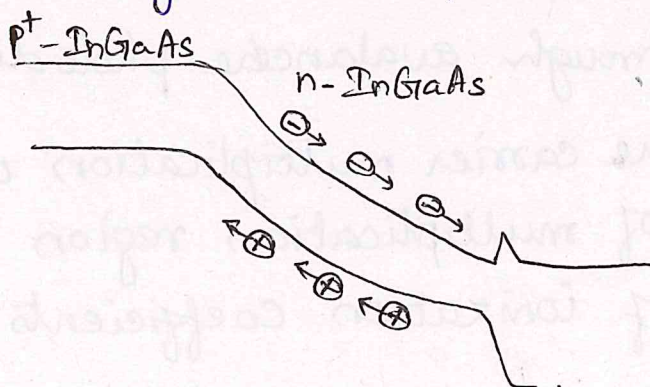



In the above device, a depleted InGaAs layer of around  $3\mu\text{m}$  is used which provides high quantum efficiency and bandwidth. Low doping permits full depletion of InGaAs layer at low volt. Bandwidth of these detectors amount 1 to 2 GHz.

A photodiode containing waveguide structure known as mushroom waveguide can be used to overcome bandwidth-quantum efficiency. In this structure, the light travels in different directions and device bandwidth and the quantum efficiency are not too dependent on each other. Hence, quantum efficiencies of greater than 80% at a bandwidth of 10 GHz is obtained using this structure.

### Avalanche Photodiodes:

To create high field region as well as the depletion region where most of the photons are absorbed and primary carrier pairs generated, there is a high field region in which holes and electrons acquire energy to excite new hole- $e^-$  pairs. The process is impact ionization, this leads to avalanche break down.

### Silicon reach through avalanche photodiodes:

→ To ensure carrier multiplication without noise, thickness of multiplication region is necessary to reduce ratio of ionization coefficients.



For low noise, electric field at avalanche breakdown must be low & impact ionization should be initiated by electrons. For this, reach thro' structure is implemented.

Silicon reach thro' consists of  $p^+-\pi-p-n^+$  layers.

\* When depletion region widens due to increase in reverse bias, it reaches through lightly doped  $\pi$ -region. Since  $\pi$  region is wider than  $p$ -region, the field in  $\pi$ -region is lower than at  $p-n^+$  region.

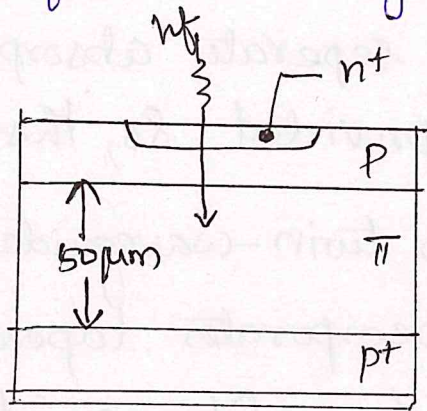

a) Structure of RAPD

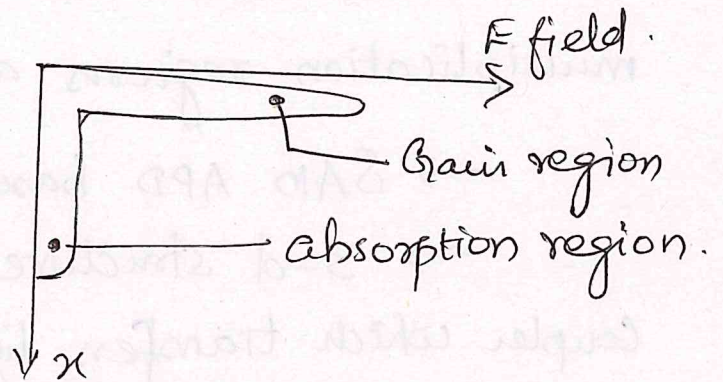

b) field distribution.

Germanium Avalanche Photodiode:

- Ge is used to fabricate sensitive & fast APDs.
- Conventional  $n+p$  structure exhibits dark current (100-300 nA) near breakdown.
- dark current includes bulk & surface current
- Reduce bulk current to provide low noise
- High absorption coefficient by Ge.



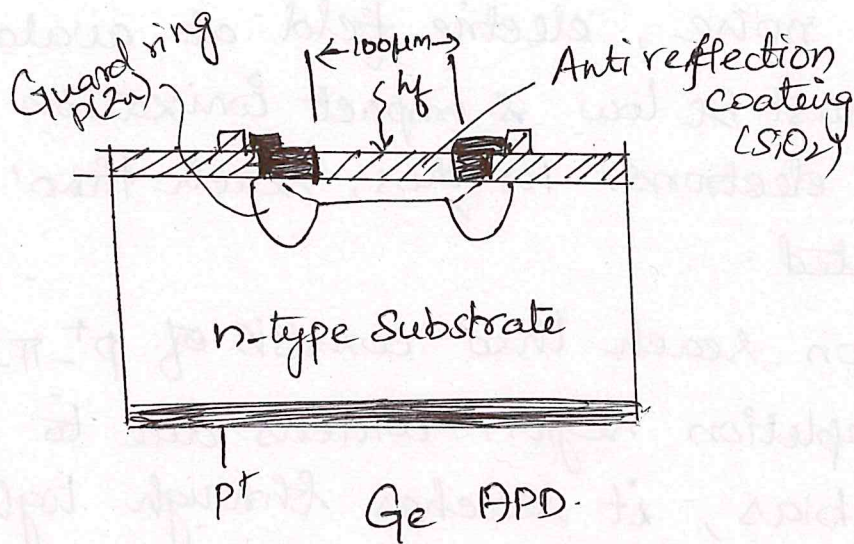

### III - V alloy APD:

Silicon reach thro' APD separate absorption and multiplication regions are provided. So, this is SAM APD.

→ SAM APD based on twin-waveguide technique  
 → 3-d structure incorporates tapered fiber coupler which transfers light from fiber guide to coupling guide sections.

→ A layer of InAlAs is used as gain region to achieve high band width operation.

→ handles 40 Gb/s transmission rate.

→ To improve speed of response is to provide InGaAsP buffer to create compositional grading.

→ This maybe achieved by MQW structure between narrow and wide band gap layer.



## Comparison of Performance:

### Advantages of APD:

- 1) APDs have advantage over photo diodes without internal gain for detection of very low light levels.
- 2) They provide increase in sensitivity over PIN photo diode.

### Drawbacks of APD:

- 1) Fabrication is difficult due to complex structure & increased cost
- 2) Random nature of gain mechanism provides additional noise.
- 3) Variation of gain with temperature.

### Multiplication factor:

- Measure of internal gain provided by APD.

$$M = I/I_p \quad \text{where } I - \text{Total op current at operating volt}$$

$$I_p - \text{Primary Photo current}$$

### Photo detector noise:

- Noise is undesired disturbance.

Types: 1) Thermal Noise.

- Spontaneous fluctuation due to thermal interaction between free  $e^-$ s & vibrating ions in conducting medium.

Thermal noise current  $i_t^2 = 4kTB/R$

where  $k$  - Boltzmann constant

$T$  - absolute temperature

$B$  - Bandwidth.



2) Dark current noise:

when there is no optical power incident on photo detector, small reverse leakage current flows.

This contributes to total system noise & gives random fluctuation about photo current

$$\text{Dark current noise} \Rightarrow \sigma_d^2 = 2eB I_d$$

where  $e$  - charge of  $e^-$        $I_d$  - dark current

It is reduced by careful design & fabrication of detector.

3) Quantum noise:

It arises from statistical nature of production & collection of photo electrons.

$$\sigma_q^2 = 2q I_p B M^2 F(M) \quad M - \text{Multiplication factor}$$

Noise Sources:

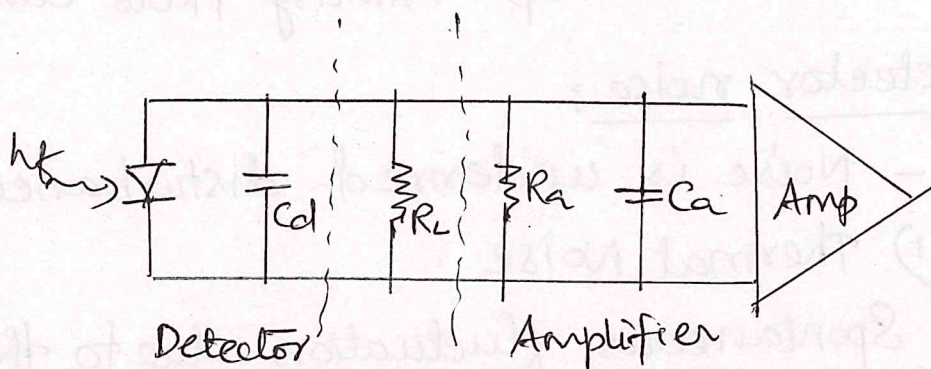

Photo detector receiver model

Main sources of noise: dark current noise + Quantum noise

$$\text{Shot noise } \sigma_{st}^2 = 2eB (I_p + I_d)$$

To include back ground radiation induced photocurrent

$$\sigma_{st}^2 = 2eB (I_p + I_d + I_b)$$



Thermal noise due to load resistance is

$$\overline{i_t^2} = 4kTB/R$$

Total noise associated with amplifier is

$$\overline{i_{amp}^2} = \int_0^B (i_a^2 \times V_a^2 |Y|^2) df \quad \begin{array}{l} Y - \text{shunt admittance} \\ f - \text{frequency.} \end{array}$$

SNR:

-obtained by summing noise contributions.

$$\frac{S}{N} = \frac{I_p^2}{2eB(I_p + I_d) + \frac{4kTB}{R_L} + \overline{i_{amp}^2}}$$

Thermal noise reduced by increasing  $R_L$ .

Amplifier noise reduced with low detector & amplifier capacitance.

Thermal noise from load resistor will be:

$$\overline{i_t^2} \times \overline{i_{amp}^2} = \frac{4kTB F_n}{R_L}$$

$$S/N = \frac{I_p^2}{2eB(I_p + I_d) + \frac{4kTB F_n}{R_L}}$$

Detector Response Time:

In reverse biased PN junction,  $e^-$  hole pairs generated due to absorption of incident photons will be separated by reverse bias volt.

In steady state, current <sup>density</sup> flows reverse biased depletion layer is

$$J_{tot} = J_{diff} + J_{drift}$$

$J_{diff}$  - diffusion current density due to carriers generated outside depletion region

$J_{drift}$  - drift current density due to carriers inside depletion region



Response Time :

It depends on

- 1) Transit time of photo carriers within depletion region
- 2) Diffusion time of photo carriers outside depletion region
- 3) RC time constant of photo diode.

Transit Time :

- Ratio of depletion layer width to carrier drift velocity.  $t = w/v_d$

Diffusion Time :

Diffusion process is slow & diffusion time is less than carrier drift time in high field region. This increases response speed of photo diode.

Response time is described by the rise time & fall time of detector o/p.

Rise Time :

It is measured from 10% to 90% of the leading edge of the o/p pulse.

Fall Time :

It is measured from 90% to 10% of falling edge of o/p pulse.

For fully depleted photo diodes, rise time & fall time are same.



## Temperature Effects:

→ The gain mechanism of APD is temperature sensitive due to temp. dependence of  $e^-$  & hole ionization rates.

→ Temp. dependence is critical at high bias volt.

→ Small change in temp. causes large changes in gain.

→ To maintain constant gain, as temp. changes, electric field in the multiplying region of pn junction also be changed. This requires that receiver incorporates a compensation circuit that adjusts the applied bias volt on photo detector when temp. changes.

→ Temp. dependent expression  $M = \frac{1}{1 - (U/V_B)^p}$

where  $V_B$  - Breakdown volt at which  $M \rightarrow \infty$

Since breakdown volt. is known to vary temp.

as  $V_B(T) = V_B(T_0) [1 + \alpha(T - T_0)]$ .







1) A double heterojunction InGaAsP LED operating at 1310 nm radiative and non-radiative recombination times of 30 and 100 ns respectively. The current injected is 40 mA. Calculate i) Bulk recombination life time ii) Internal quantum efficiency, iii) internal power level.

$$\lambda = 1310 \text{ nm}, \tau_r = 30 \text{ ns}, \tau_{nr} = 100 \text{ ns}, I = 40 \text{ mA}$$

i) Bulk recombination time ( $\tau$ ):

$$\frac{1}{\tau} = \frac{1}{\tau_r} + \frac{1}{\tau_{nr}}$$

$$\frac{1}{\tau} = \frac{1}{30} + \frac{1}{100}$$

$$\therefore \tau = 23.07 \text{ nsec.}$$

ii) Internal quantum efficiency  $\eta_{int} = \frac{\tau}{\tau_r}$

$$\eta_{int} = \frac{23.07}{30} = 0.769$$

iii) Internal power level  $P_{int} = \eta_{int} \frac{hcI}{q\lambda}$

$$P_{int} = 0.769 \frac{(6.625 \times 10^{-34}) (3 \times 10^8) (0.04)}{(1.602 \times 10^{-19}) (1.31 \times 10^{-6})}$$

$$= 2.913 \text{ mW.}$$

2) A GaAs laser operating at 950 nm and has length of 500  $\mu\text{m}$ , refractive index  $n = 3.7$ . Calculate frequency and wavelength spacings.

$$\lambda = 950 \text{ nm}, L = 500 \mu\text{m}, n = 3.7$$

$$\text{Frequency spacing } \Delta\nu = \frac{c}{2Ln} = \frac{3 \times 10^8}{2 \times 500 \times 10^{-6} \times 3.7} = 81 \text{ GHz}$$

$$\text{Wavelength spacing } \Delta\lambda = \frac{\lambda^2}{2Ln}$$

$$= \frac{(950 \times 10^{-9})^2}{2 \times 500 \times 10^{-6} \times 3.7} = 0.19 \text{ nm}$$



3) Photons having energy  $1.53 \times 10^{-19} \text{ J}$  are incident on a photo diode having responsivity of  $0.65 \text{ A/W}$ . If opt power is  $10 \mu\text{W}$ . Find the generated photo current. (May-12)

$$R = 0.65 \text{ A/W}, P_0 = 10 \mu\text{W}$$

$$R = I_p / P_0; I_p = R P_0 = 0.65 \times 10 = 6.5 \mu\text{A}$$

4) A ruby laser contains a crystal length  $4 \text{ cm}$  with refractive index  $1.78$ . The peak emission wavelength from device is  $0.55 \mu\text{m}$ . Determine no. of longitudinal modes & frequency separation.

$$L = 4 \text{ cm}, n = 1.78, \lambda = 0.55 \mu\text{m}$$

$$\text{No. of longitudinal modes } q = \frac{2nL}{\lambda}$$

$$q = \frac{2 \times 1.78 \times 0.04}{0.55 \times 10^{-6}} = 2.58 \times 10^5$$

Frequency separation of mode is

$$\Delta f = \frac{c}{2nL} = \frac{3 \times 10^8}{2 \times 1.78 \times 0.04} = 2.1 \text{ GHz}$$

5) A photo diode is constructed GaAs which has a band gap energy of  $1.43 \text{ eV}$  at  $300\text{K}$ . Find the long wavelength cutoff.

$$E_g = 1.43 \text{ eV}$$

$$\lambda_c = \frac{1.24}{E_g} = \frac{1.24}{1.43} = 0.867 \mu\text{m}$$

6) A given silicon APD has quantum efficiency  $65\%$  at a wavelength  $900 \text{ nm}$ . Suppose  $0.5 \mu\text{W}$  optical power produces multiplied photo current  $10 \mu\text{A}$ . Find multiplication factor.

$$\text{Responsivity } R = \frac{\eta e \lambda}{h\nu}$$



$$= \frac{0.65 \times 1.602 \times 10^{-19} \times 900 \times 10^9}{6.626 \times 10^{-34} \times 2.998 \times 10^8} = 0.4717 \text{ Aw}^{-1}$$

The Photo current  $I_p = P_o qR$

$$I_p = 0.5 \times 10^{-6} \times 0.4717 = 0.2 \mu\text{A}$$

$$\text{Multiplication factor } M = I/I_p = \frac{10 \times 10^{-6}}{0.23 \times 10^{-6}} = 43.47$$

7) Calculate the external differential quantum efficiency of LASER diode operating at  $1.33 \mu\text{m}$ , slope of the straight line portion of emitted optical power  $P$  vs drive current  $I$  is given by  $15 \text{ mW/mA}$ . (Dec-11)

$$\text{Given } \lambda = 1.33 \mu\text{m}$$

$$\frac{dP}{dI} = 15 \text{ mW/mA}$$

$$E_g = \frac{1.24}{\lambda} = \frac{1.24}{1.33} = 0.932 \text{ eV}$$

$$\eta_D = \frac{dP}{dI} \cdot \frac{1}{E_g} = 15 \times \frac{1}{0.932} = 16.09$$

8) If absorption coefficient of silicon is  $0.05 \mu\text{m}^{-1}$  at  $860 \text{ nm}$ , find the penetration depth at which  $P(x)/P_{in} = 0.368$  (May-14)

$$\text{Given: } \alpha_s(\lambda) = 0.05 \mu\text{m}^{-1}; \quad P(x)/P_{in} = 0.368$$

$$P(x) = P_{in} (1 - e^{-\alpha(\lambda)x})$$

$$\frac{P(x)}{P_{in}} = (1 - e^{-\alpha(\lambda)x})$$

$$0.368 = 1 - e^{-0.05x}$$

$$\therefore x = 2.11 \mu\text{m}$$



9) A GaAs optical source with a refractive index of 3.6 is coupled to a silica fiber that has a refractive index 1.48. What is the reflectivity for normal incidence of plane wave. (May 19)

$$n_1 = 3.6 \quad n_2 = 1.48$$

Plane wave reflection from media interface at

$$\text{normal incidence} = \frac{2n_2}{n_1 + n_2}$$

$$= \frac{2 \times 1.48}{(3.6 + 1.48)} = \frac{2.96}{5.08} = 0.5823$$

10) Find the optical gain at threshold of a laser diode having following parametric values  $R_1 = R_2 = 0.32$ ,  $\bar{\alpha} = 10 \text{ cm}^{-1}$  and  $L = 500 \mu\text{m}$ .

Optical gain in laser diode is

$$\Gamma g_{th} = \bar{\alpha} + \frac{1}{2L} \ln \left( \frac{1}{R_1 R_2} \right)$$

$$\Gamma g_{th} = 10 + \frac{1}{2 \times 500 \times 10^{-4}} \ln \frac{1}{0.32 \times 0.32}$$

$$= 33.7 \text{ cm}^{-1}$$



## Unit iv . Optical Receiver , Measurements and Coupling .

### Fundamental Receiver Operation :

An optical receiver system converts optical energy into electrical signal at the detector, then amplify the signal to obtain a suitable signal level.

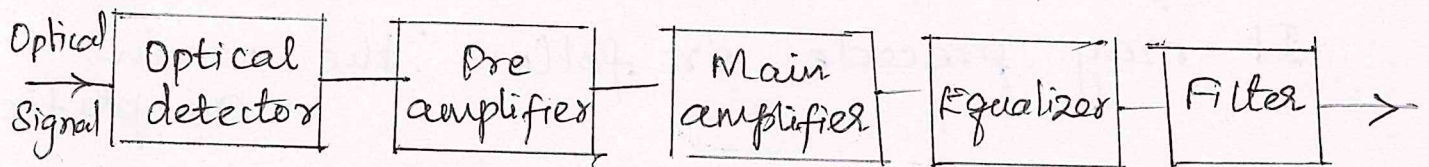

It is essential that additional noise is kept to a minimum in order to avoid corruption of received signal.

As noise sources within the preamplifier may be dominant, its configuration and design are major factors in determining sensitivity.

→ Main amplifier provides additional low noise amplification of the signal to give an increased signal level for the remaining circuits.

→ Optical detectors are very linear devices and don't introduce significant distortion onto the signal, other components exhibit non linear behaviours.



Received optical signal maybe distorted due to dispersive mechanisms within optical fiber. Also, transfer function of preamplifier-main amplifier combination maybe that input signal is distorted.

To compensate this distortion & to provide suitable signal shape for the filter, an equalizer is included in the receiver. It may precede or follow the main amplifier.

The filter is used to maximize the received signal to noise ratio while preserving the essential features of signal.

In digital systems, the function of filter is to reduce intersymbol interference;

In analog systems, it is required to hold amplitude and phase response of the received signal within certain limits.

The filter is also designed to reduce noise bandwidth & band noise levels.

Generally, receiver consists of the elements is referred as linear because operations are linear



## Digital Signal Transmission:

A digital fiber transmission link is shown in figure.

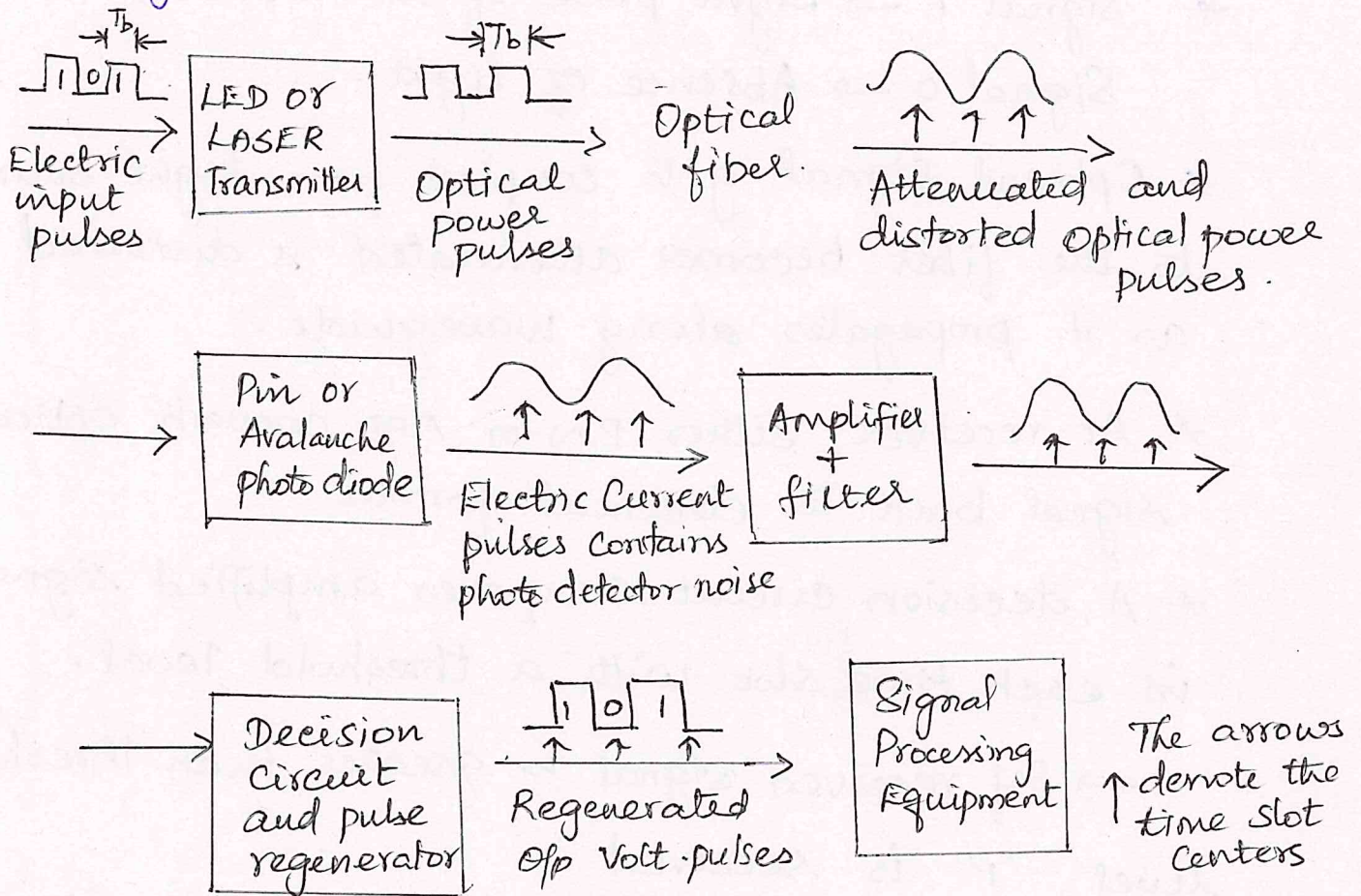

\* The transmitted signal is a two level binary data stream consists of either '0' or '1' in a bit period  $T_b$ .

\* Simplest technique for sending binary data is Ask (Amplitude Shift Keying), wherein voltage level is switched between on or off values.

\* Resultant wave consists of Volt. pulse of amplitude  $V$  when a binary 1 occurs and zero-volt-level space when a binary 0 occurs.



\* An electric current  $i(t)$  is used to modulate directly an optical source to produce an optical output power  $P(t)$ .

\* Signal 1  $\rightarrow$  Light pulse of duration  $T_b$ .  
Signal 0  $\rightarrow$  Absence of light.

\* Optical signal gets coupled from light source to the fiber becomes attenuated & distorted as it propagates along waveguide.

\* At receiver, either PIN or APD converts optical signal back to electrical format.

\* A decision circuit compares amplified signal in each time slot with a threshold level.

$\rightarrow$  If received signal is greater than threshold level, '1' is received  
 $\rightarrow$  If volt. is below threshold level, '0' is received.

### The Preamplifier:

The choice of circuit configuration for the preamplifier is dependent upon the systems application.

BJT / FETs can be operated in three useful connections:

- 1) Common emitter or source
- 2) Common base or gate
- 3) Common collector or drain



Basic preamplifier structures are

Low - impedance

High - impedance

Trans impedance front-end amplifiers.

1) Low input impedance voltage amplifier :

→ implemented using BJT because of high input impedance FETs.

→ CE configuration gives operation over a moderate bandwidth without need for equalization.

→ To reduce thermal noise contribution of preamplifier by choosing a transistor with characteristic that gives high current gain at low emitter current to maintain bandwidth of stage.

Also, inductance is inserted at the collector to provide partial equalization for any integration performed by the stage.

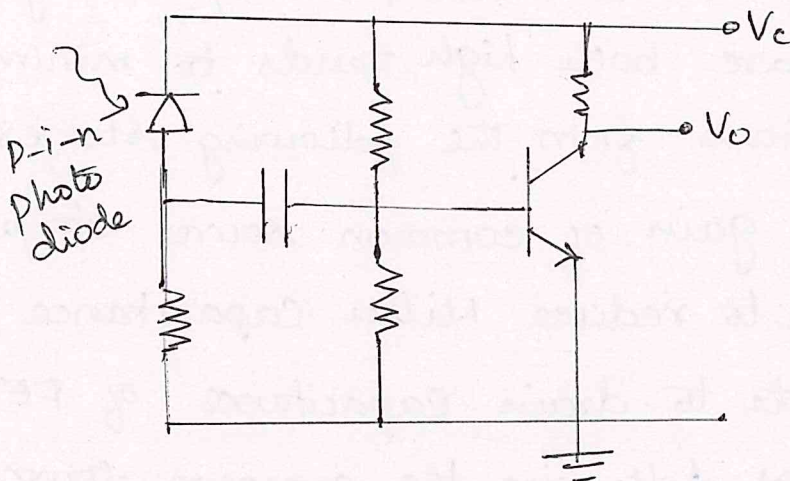

The preferred preamplifier configurations for low noise operation use either high impedance integrating front-end or trans impedance amplifier.



BJT incorporated in emitter follower is used to realize high impedance front end amplifier, FET is generally employed for this purpose because of low noise operation.

Grounded source FET connection was a useful circuit to provide high impedance front end amplifier.

FET Common source amplifier configuration which provides high input impedance for p-in photo diode is shown in fig.

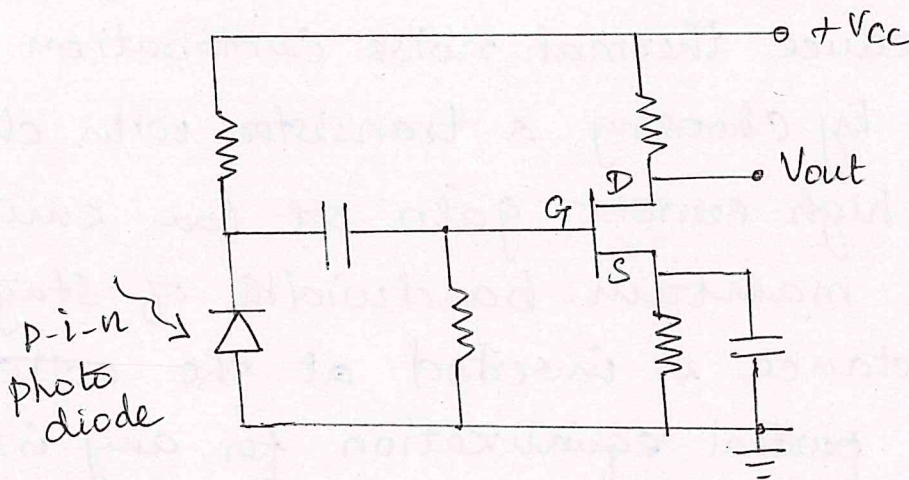

When operating in the mode, FET power gain + output impedance are both high, tends to minimize any noise contributions from the following stages.

When voltage gain of common source stage is minimized in order to reduce Miller capacitance associated with gate to drain capacitance of FET. This is achieved by following the common source stage with stage having low-input impedance.



## Front end Amplifier:

The trans impedance or shunt feedback amplifier finds wide application in pre amplifier design for fiber communication. The front-end structure acts as current-voltage converter gives low noise performance. It also provides high dynamic range than high input impedance structure. The noise performance of transimpedance amplifier is not quite as good.

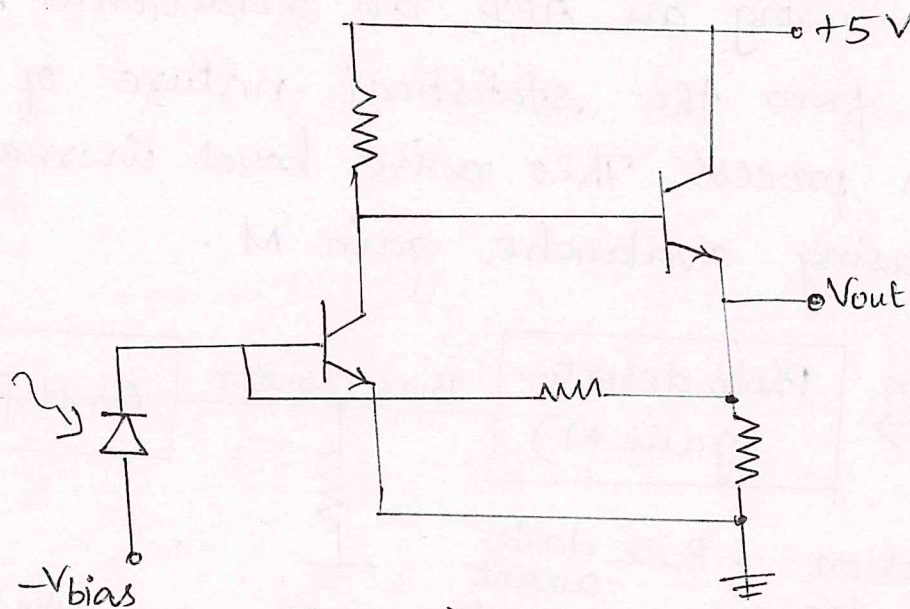

Transimpedance front end Configuration.

## Error Sources:

\* Errors in the detection mechanism can arise from various noises and disturbances associated with signal detection systems.

\* Samples of spontaneous fluctuations are shot noise & thermal noise.

\* Shot noise arises in devices because of discrete nature of current flow in the device.



\* Thermal noise arises from the random motion of electrons in a conductor.

\* The random arrival rate of signal photons produces a quantum (or shot) noise at the photo detector. The noise depends on the signal level.

\* The noise is for PIN receivers that have large optical input levels and for APD receivers.

\* When using an APD, an additional shot noise rises from the statistical nature of the multiplication process. This noise level increases with increasing avalanche gain  $M$ .

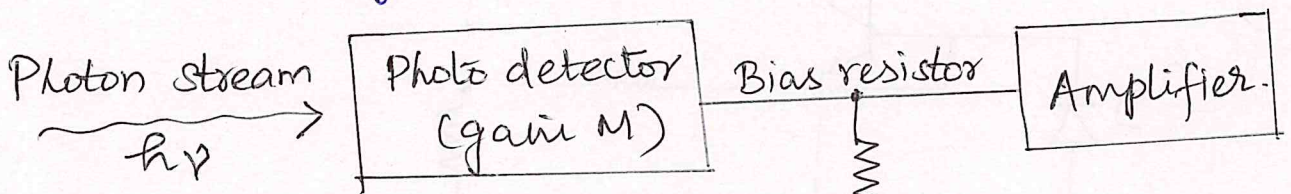

- Photo detection quantum noise (Poisson fluctuation)
- Bulk dark current
- Surface leakage current
- Statistical gain fluctuation (for avalanche photo diodes).
- Thermal noise
- Amplifier noise

\* Thermal noises arising from detector load resistor and from amplifier electronics tend to dominate in applications with low SNR when a PIN photo diode is used.

\* When an APD is used in low-optical-signal level applications, optimum avalanche gain is determined by a design trade-off between thermal noise and gain dependent quantum noise.



\* When an APD is used in low optical signal level applications, the optimum avalanche gain is determined by a design tradeoff between the thermal noise and gain-dependent quantum noise.

\* The primary photo current generated by the photo diode is a time varying poisson process.

\* If the detector is illuminated by an optical signal  $P(t)$ , then the average no. of electron-hole pairs generated in a time  $t$  is

$$\bar{N} = \frac{\eta}{h\nu} \int_0^t P(t) dt = \frac{\eta E}{h\nu}$$

where  $\eta$  - detector quantum efficiency  
 $h\nu$  - photon energy  
 $E$  - Energy received in time interval.

\* The actual no. of electron-hole pairs  $n$  that are generated fluctuates from the average according to the Poisson distribution

$$Pr(n) = \bar{N}^n \frac{e^{-\bar{N}}}{n!}$$

where  $Pr(n)$  is the probability that  $n$  electrons are emitted in an interval  $t$ .

\* For a detector with a mean avalanche gain  $M$  and an ionization rate ratio  $k$ , the excess noise factor  $F(M)$  for electron injection is

$$F(M) = kM + (2 - \frac{1}{M})(1-k) \approx M^x$$

$x \approx 0$  to  $1$  depends on photo diode material



\* Another error source is attributed to intersymbol interference (ISI) which results pulse spreading in the optical fiber.

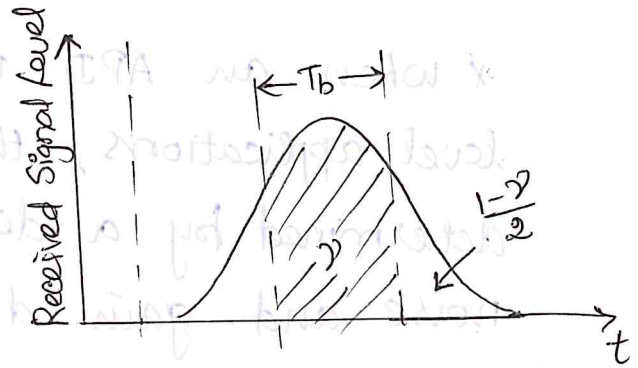

Pulse spreading in an optical signal that leads to ISI

\* The fraction of energy remaining in the appropriate time slot is designated by  $\gamma$ , so  $1-\gamma$  is the fraction of energy that has spread into adjacent time slots.

### Receiver Configuration:

- Stages of receiver  $\rightarrow$
- 1) Photo detector
  - 2) Amplifier
  - 3) Equalizer.

\* Photo detector can be either APD with mean gain  $M$  or a PIN for which  $M=1$ .

\* The photo diode has quantum efficiency  $\eta$  & Capacitance  $C_d$ .

\* The detector bias resistor has a resistance  $R_b$  which generates thermal noise current  $i_b(t)$ .

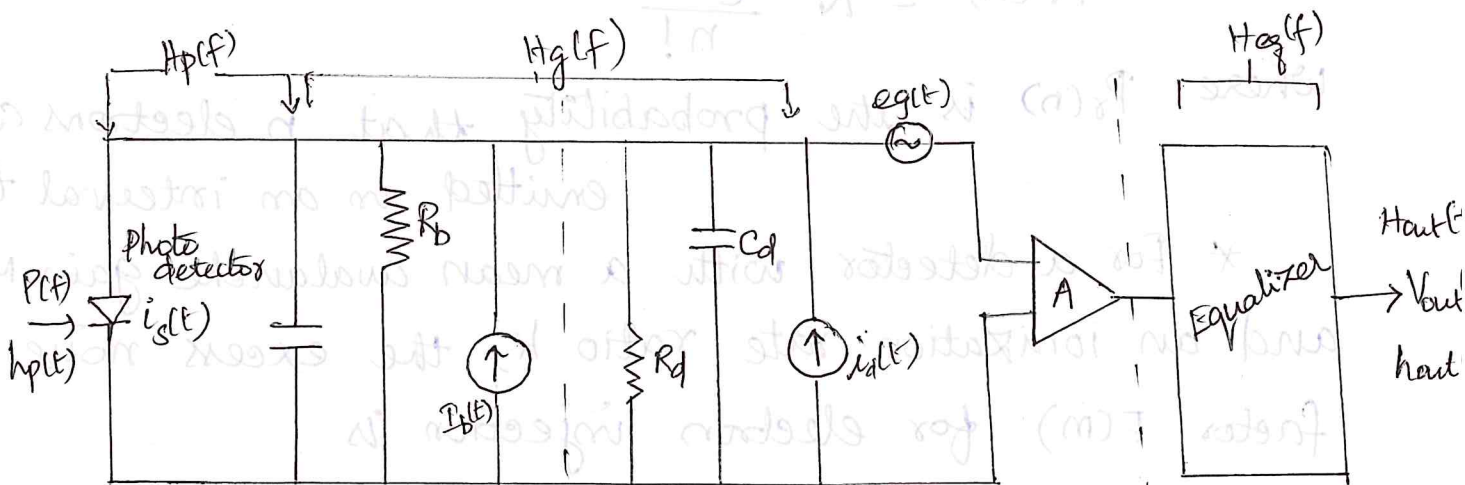

Photo detector and its bias resistor | Amplifier and its input parameters



## Amplifier noise Sources:

- The input noise current source  $i_{act}$  arises from the thermal noise of the amplifier input resistance  $R_a$ .
- The noise voltage source  $e(t)$  represents the thermal noise of the amplifier channel.
- The noise sources are assumed to be Gaussian in statistics, flat in spectrum (which characterizes white noise) and uncorrelated (statistically independent).

## The Linear Equalizer:

\* The equalizer is a linear frequency shaping filter that is used to mitigate the effects of signal distortion and inter symbol interference (ISI).

\* The equalizer accepts the combined frequency response of the transmitter, the fiber, receiver and transforms it into signal response suitable for the following signal processing electronics.

\* The binary digital pulse train incident on the photo detector can be described by

$$P(t) = \sum_{n=-\infty}^{\infty} b_n h_p(t - nT_b)$$

Here,  $P(t)$  is received optical power

$T_b$  is bit period

$b_n$  is an amplitude parameter representing  $n^{\text{th}}$  message digit

$h_p(t)$  is received pulse shape.



Let the non negative photo diode input pulse  $h_p(t)$  be normalized to have unit area

$\int_{-\infty}^{\infty} h_p(t) dt = 1$  then  $h_n$  represents energy in the  $n^{\text{th}}$  pulse.

\* The mean output current from the photo diode at time  $t$  resulting from the pulse train given previously is

$$\langle i(t) \rangle = \frac{hq}{h\nu} MP(t) = R_0 \sum_{n=-\infty}^{\infty} h_n h_p(t - nT_b)$$

where  $R_0 = hq/h\nu$  is photo diode responsivity.

The above current is amplified and filtered to produce a mean voltage at the output of equalizer.

### Digital Receiver Performance:

Ideally, in a digital receiver, output voltage exceeds the threshold voltage when '1' is present & less than threshold when no pulse was sent.

In actual systems, deviations from average value of output are due to various noises and interference.



## Probability of Error:

Digital receiver performance can be evaluated by measuring

- \* probability of error
- \* Quantum limit.

In a digital receiver, the amplified and filtered signal emerging from equalizer is compared with threshold level once per time slot to determine whether or not a pulse is present at the photo detector in the time slot.

Bit Error Rate (BER) is defined as:

$$BER = N_e / N_t = N_e / Bt$$

where  $B = 1/T_b$  (bit rate).  $N_e, N_t$ : No. of errors, pulses

\* To compute the BER at the receiver, we have to know the probability distribution of the signal at the equalizer output.

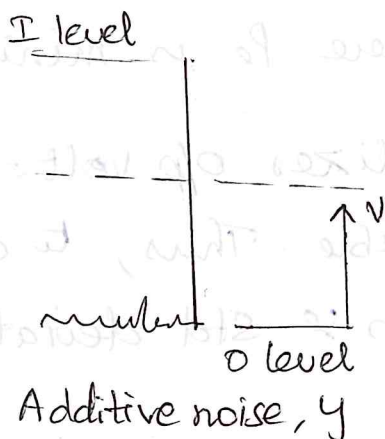

Probability distributions for received '0' and '1' signal.

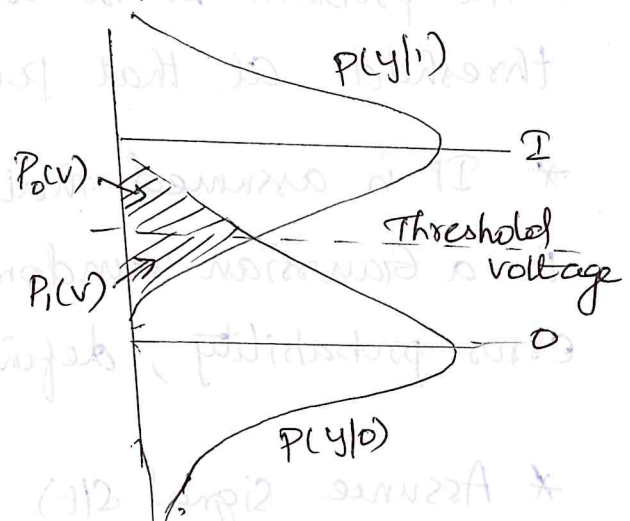

Different widths of two distributions caused by various signal distortion effects



In fig,  $P_1(v) = \int_{-\infty}^v P(y|1) dy$  which is the probability that equalizer output voltage is less than  $v$  when logical '1' pulse is sent and

$P_0(v) = \int_v^{\infty} P(y|0) dy$  which is the probability that o/p voltage exceeds  $v$  when logical '0' is transmitted.

\* The function  $\phi(y|x)$  is the conditional probability that the output voltage is  $y$ , given that  $x$  was transmitted.

\* If threshold volt. is  $v^{th}$ , then error probability  $P_e = a P_1(v^{th}) + b P_0(v^{th})$

\* The weighting factors  $a$  &  $b$  are determined by priori distribution of data.

\* For unbiased data with equal probability of '1' & '0' occurrences,  $a = b = 0.5$

\* The problem to be solved is to select the decision threshold at that point where  $P_e$  is minimum.

\* It is assumed that equalizer o/p volt.  $V_{out}(t)$  is a Gaussian random variable. Thus, to calculate error probability, define mean & std deviation of  $V_{out}(t)$ .

\* Assume signal  $s(t)$  has Gaussian pdf  $f(s)$  with mean value  $m$ . The signal sample at  $s$  to  $s+ds$  is

$$f(s) ds = \frac{1}{\sqrt{2\pi}\sigma} e^{-\frac{(s-m)^2}{2\sigma^2}} ds ; \quad \begin{array}{l} \sigma^2 - \text{noise variance} \\ \sigma - \text{std deviation.} \end{array}$$



\* The quantity measures the full width of probability distribution at the point where amplitude is  $1/2$  of the maximum.

In fig, mean and variance of Gaussian of p for '1' pulse are  $b_{on} + \sigma_{on}^2$ ; for '0' pulse,  $b_{off} + \sigma_{off}^2$ .

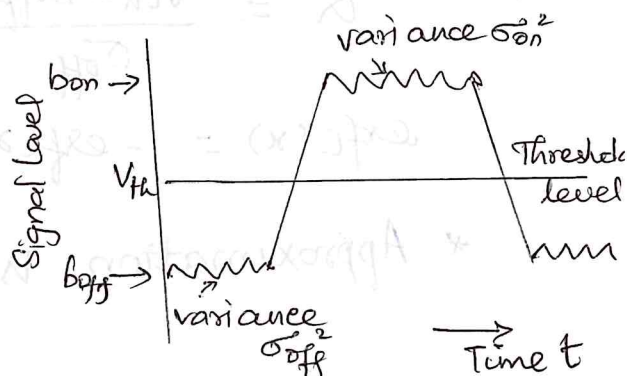

\* Probability of error  $P_e(v)$  is the chance that the equalizer of volt.  $v(t)$  will fall between  $V_{th}$  &  $\infty$

$$P_e(V_{th}) = \int_{V_{th}}^{\infty} p(y|0) dy = \int_{V_{th}}^{\infty} f_0(v) dv$$

$$= \frac{1}{\sqrt{2\pi} \sigma_{off}} \int_{V_{th}}^{\infty} \exp\left[-\frac{(v - b_{off})^2}{2\sigma_{off}^2}\right] dv$$

where subscript 0 denotes presence of '0' bit.

\* Similarly, error probability of transmitted '1' is misinterpreted as '0' is the likelihood that sampled signal plus noise pulse falls below  $V_{th}$ .

$$P_e(V_{th}) = \int_{-\infty}^{V_{th}} p(y|1) dy = \int_{-\infty}^{V_{th}} f_1(v) dv$$

$$= \frac{1}{\sqrt{2\pi} \sigma_{on}} \int_{-\infty}^{V_{th}} \exp\left[-\frac{(b_{on} - v)^2}{2\sigma_{on}^2}\right] dv$$

where subscript 1 denotes the presence of '1' bit.

Assume, '0' and '1' pulses are equally likely, the

$$BER = P_e(0) = \frac{1}{\sqrt{\pi}} \int_{Q/\sqrt{2}}^{\infty} e^{-x^2} dx$$



$$BER = \frac{1}{2} \left[ 1 - \operatorname{erf} \left( \frac{Q}{\sqrt{2}} \right) \right] \approx \frac{1}{\sqrt{2\pi}} \frac{e^{-Q^2/2}}{Q}$$

$$Q = \frac{V_{th} - b_{off}}{\sigma_{off}} = \frac{b_{on} - V_{th}}{\sigma_{on}} = \frac{b_{on} - b_{off}}{\sigma_{on} + \sigma_{off}}$$

$$\operatorname{erfc}(x) = 1 - \operatorname{erf}(x) = \frac{2}{\sqrt{\pi}} \int_x^{\infty} e^{-y^2} dy \xrightarrow{\text{large } x} \frac{e^{-x^2}}{x\sqrt{\pi}}$$

\* Approximation is obtained from asymptotic expansion of error function

### Receiver Sensitivity:

Optical communication systems use BER value to specify performance requirements for particular transmission link application.

ex: SONET/SDH specify BER must be  $10^{-10}$ .

Gigabit Ethernet require BER must  $10^{-12}$ .

→ To achieve BER at a given data rate, specific min. average opt. power level must arrive at photo detector. The value of min. power level is receiver sensitivity.

→ Average optical power in dBm incident on photo detector

→ Optical modulation Amplitude (OMA) given in terms of peak to peak current at photo detector output.

→ It gives measure of min. average power or OMA needed to maintain a max BER at a specific data rate.

$$P_{\text{sensitivity}} = I_1 / 2RM$$

$I_1$  - Signal current for pulse  
 $R$  - Unity gain Responsivity  
 $M$  - Gain of photo diode.



### The Quantum Limit:

→ For an ideal photo-detector having unity quantum efficiency & producing no dark current, it is possible to find min. received optical power required for a specific BER performance in a digital system. This min. received power level is quantum limit.

### Fiber Attenuation Measurements:

Fiber attenuation is measured from both absorption losses & Scattering losses.

#### Cut back (or) differential method:

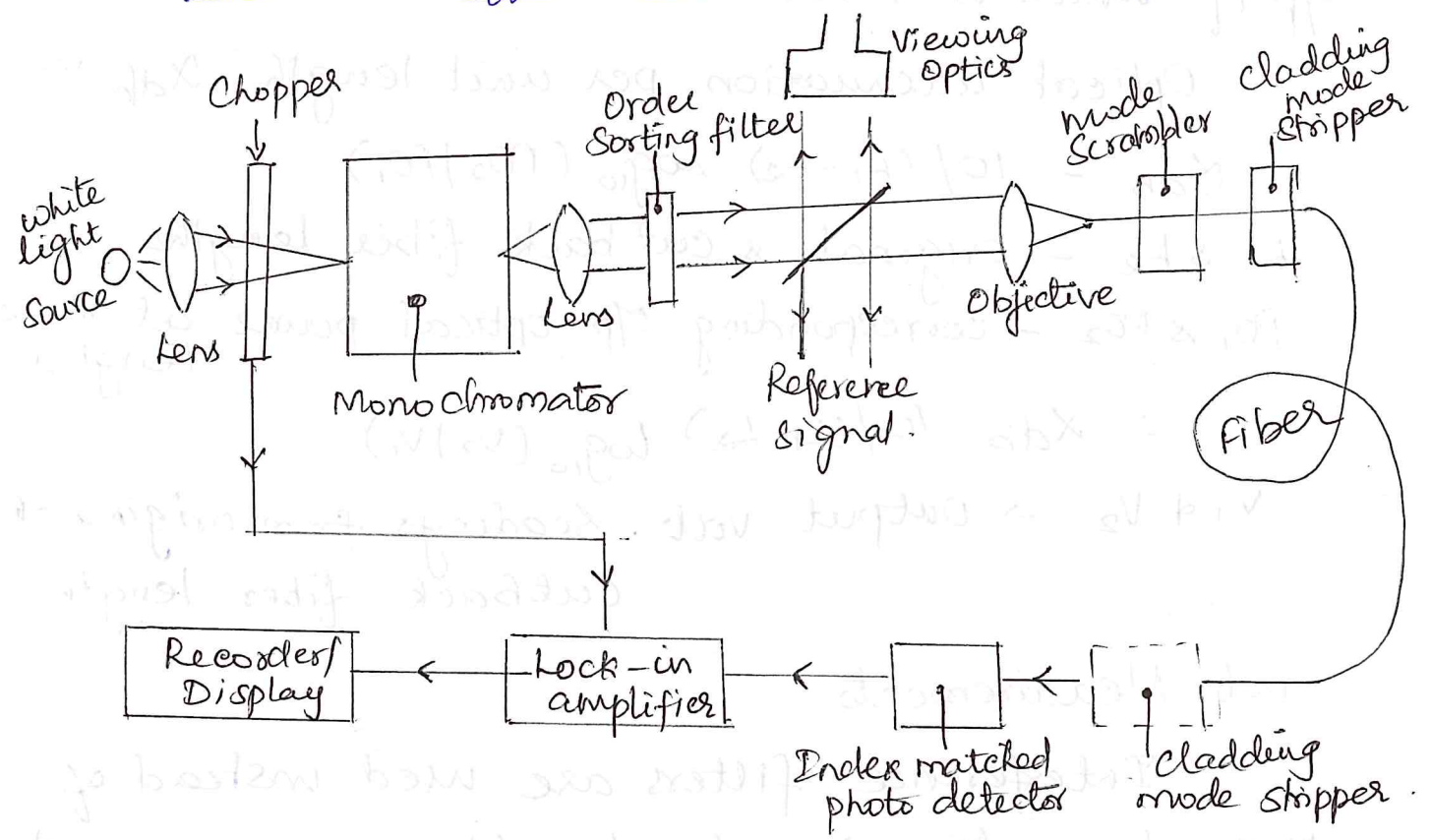

It consists of white light source (tungsten halogen or xenon lamp).

Focused light is chopped at low frequency (100 Hz) This enables lock in amplifier at receiver to perform phase sensitive detection.



Chopped light is fed thro monochromator which utilizes prism/diffraction grating to select required wavelength at which attenuation is to be measured

Light is filtered by objective lens before focused on fiber. Beam splitter provides light for viewing optics & reference signal used to compensate for o/p power fluctuations

Mode stripper at fiber o/p end removes any optical power that is scattered from core to cladding.

Optical power at receiver detected by PIN/APD. The electrical o/p is fed to a lock in amplifier, o/p of which is recorded.

Optical attenuation per unit length  $\alpha_{db}$  is

$$\alpha_{db} = 10 / (L_1 - L_2) \log_{10} (P_{O2} / P_{O1})$$

$L_1$  &  $L_2$  - original & cutback fiber lengths

$P_{O1}$  &  $P_{O2}$  - corresponding o/p optical power at these lengths.

$$\therefore \alpha_{db} = 10 / (L_1 - L_2) \log_{10} (V_2 / V_1)$$

$V_1$  &  $V_2$   $\rightarrow$  Output vab. readings from original & cutback fiber length.

Spot Measurements:

Interference filters are used instead of monochromator in order to obtain measurement at a particular optical wavelength. These provide greater dynamic range (10 to 15 db) than monochromator. The interference filters are located on a wheel to allow measurement at a selection of different wavelengths.



The source spot size is defined by pinhole and beam angular width is varied by using different diaphragms. Determination of optical loss per unit length for a fiber at a particular wavelength is performed, using cut back method.

Spot attenuation measurements are utilized after cabling to obtain information on any degradation in the fiber attenuation results from cabling process.

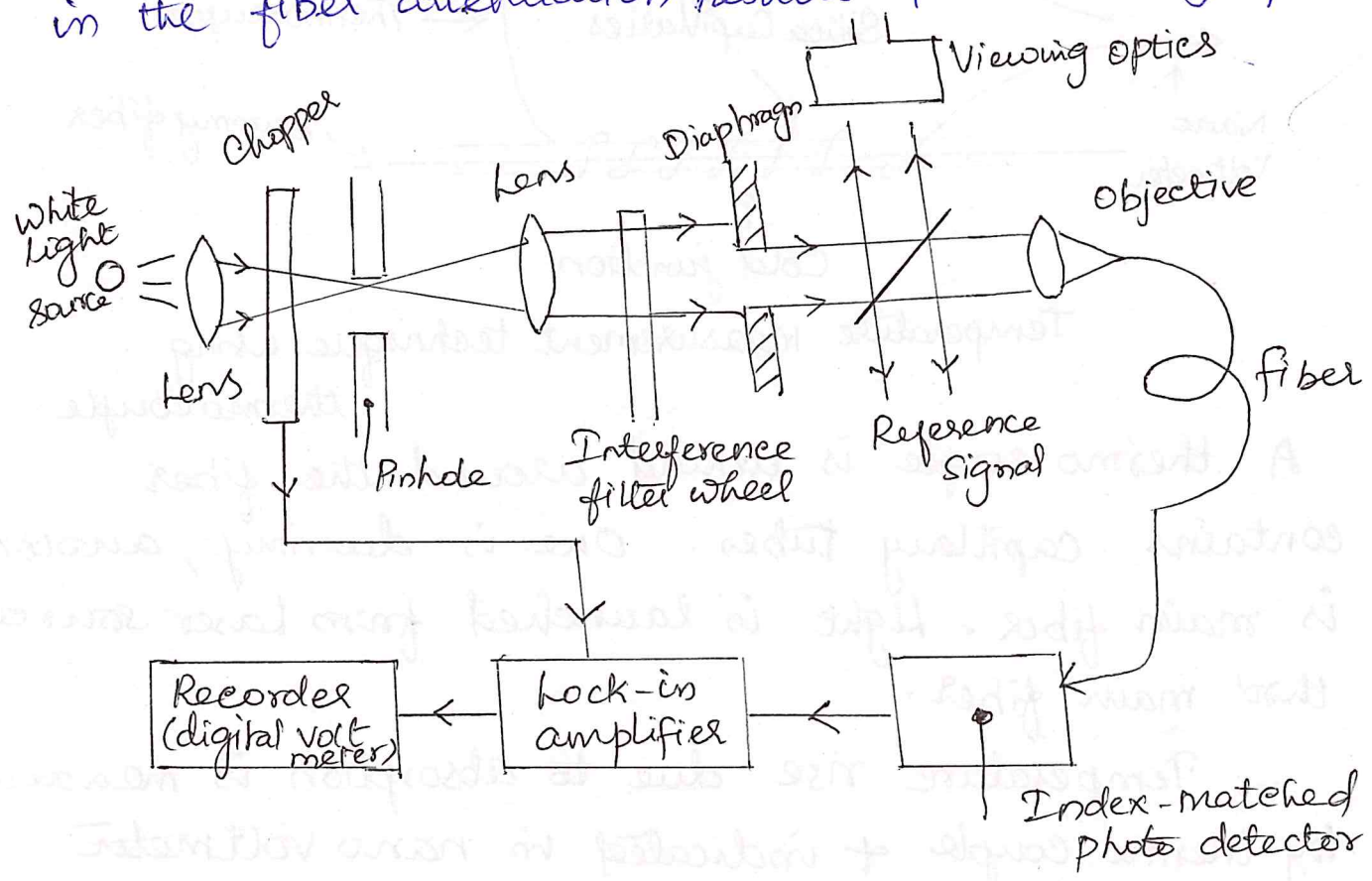

### Fiber Absorption Loss Measurement :

Material absorption loss measurements allow the level of impurity within fiber material to be checked in manufacturing process.

Measurements are based on calorimetric methods that determines temperature rise in the fiber results from absorbed optical energy within structure.



The two samples are mounted in capillary tubes surrounded by low refractive index liquid for good electrical contact. (methanol)

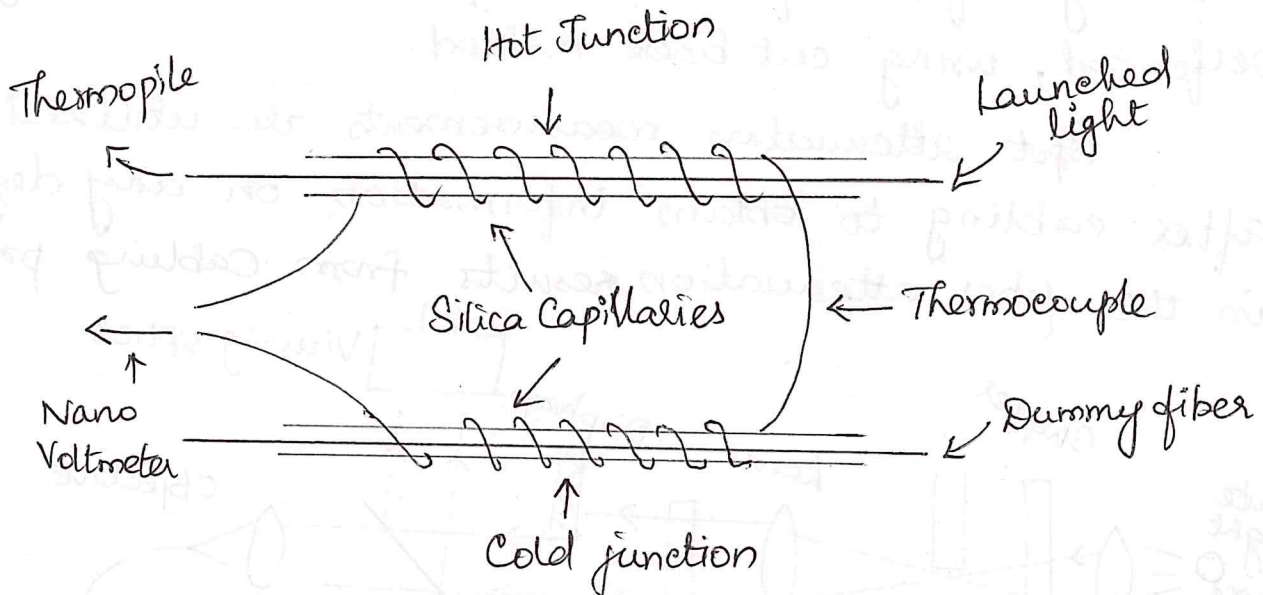

Temperature measurement technique using thermocouple.

A thermo couple is wound around the fiber contains capillary tubes. One is dummy, another is main fiber. Light is launched from laser source thro' main fiber.

→ Temperature rise due to absorption is measured by thermo couple & indicated in nano voltmeter

→ Electrical calibration is achieved by replacing optical fibers with wires & passing known electrical power through one. Calorimetric measurements provide heating & cooling curve for the sample used.

Attenuation measured by cooling characteristic Time constant  $t_c$  is obtained from plot of  $(T_\infty - T_t)$  on log scale against time  $t$ .



The time constant  $t_c$  is obtained from slope of straight line

$$t_c = \frac{t_2 - t_1}{\ln(T_{\infty} - T_{t_1}) - \ln(T_{\infty} - T_{t_2})}$$

where  $T_{\infty}$  - max. temperature rise of fiber under test.

$T_t$  - temperature rise at time  $t$ .

$t_1$  &  $t_2$  - two points in time.

$t_c$  - Time constant.

$t_c$  is constant for the calorimeter (ie) inversely proportional to rate of heat loss from the device.

Fiber attenuation due to absorption is

$$\alpha_{abs} = \frac{c T_{\infty}}{P_{opt} t_c} \text{ db/km.}$$

where  $c$  - thermal capacity per unit length of capillary tube.

$P_{opt}$  - Optical power propagates into fiber under test.

Fiber Scattering loss Measurement:

Method to measure scattering loss is to collect the light scattered from short length of fiber and compare it with total optical power propagating within fiber. Light scattered from fiber is detected in a scattering cell.

→ It consists of cube of six square solar cells (Tyne's cell - Integrating sphere + detector). Solar cell contains index-matching fluid surrounding fiber measures scattered light.



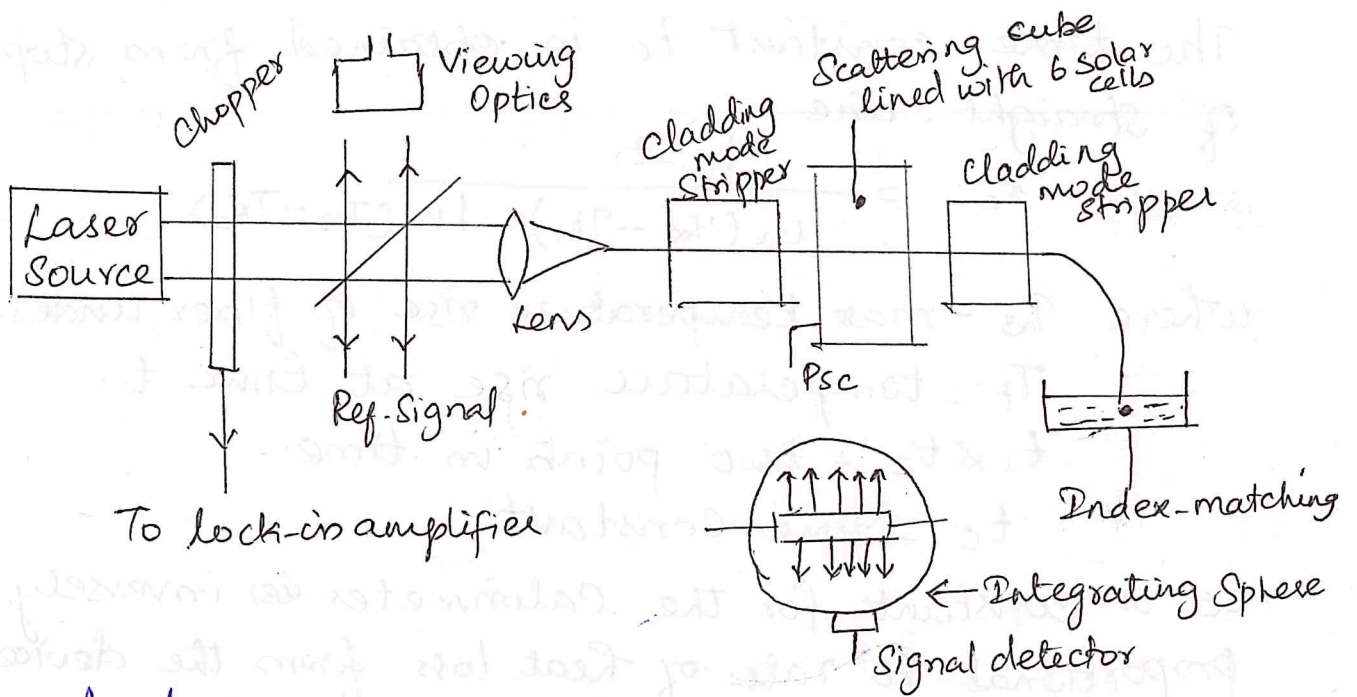

→ A laser source provides optical power with single wavelength with an instrument to measure response from detector.  $\rho$

→ Cladding mode strippers avoid inaccuracies resulting from scattered light. This removes light propagating in the cladding. To avoid reflections, off fiber end is index matched using fluid.

The loss due to scattering is,

$$\alpha_{sc} = [10 / l(\text{km})] \log_{10} (P_{opt} / (P_{opt} - P_{sc})) \text{ db/km.}$$

where  $l(\text{km})$  - length of fiber in the scattering cell.

$P_{opt}$  - Optical power propagates within fiber

$P_{sc}$  - Optical power scattered from short length of fiber

As  $P_{opt} \gg P_{sc}$ , then the logarithm may be expanded to give:

$$\alpha_{sc} = [4.343 / l(\text{km})] [\log_{10} (P_{sc} / P_{opt})] \text{ db/km.}$$



## Fiber Dispersion Measurements :

Delay distortion leads to broadening of light pulses limits information carrying capacity of fiber.

Types: Material dispersion } Intramodal dispersion  
 waveguide dispersion } - dominant in single mode  
 Intermodal dispersion - In multimode fiber

\* Dispersion effects may be characterized by taking measurements of impulse response of fiber in time domain / baseband frequency response in frequency domain.

In time domain,  $P_o(t) = h(t) * P_i(t)$

$P_o(t)$  - Optical o/p power

$P_i(t)$  - Optical i/p power

$h(t)$  - impulse response

Using Convolution integral,  $P_o(t) = \int_{-\infty}^{\infty} P_i(t-x) h(x) dx$ .

In frequency domain,  $P_o(\omega) = H(\omega) P_i(\omega)$ .

1. Time domain measurement:

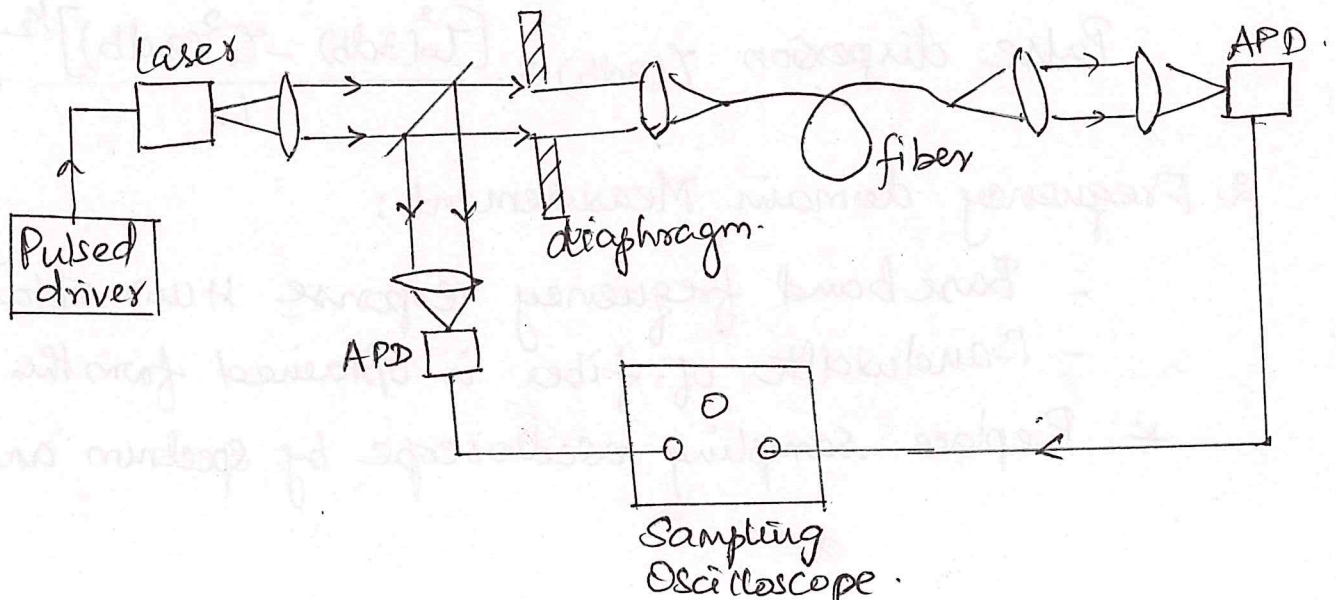



Short optical pulses are launched into fiber from source. The pulses travel down the length of fiber under test and are broadened due to various dispersion mechanisms.

Pulses are received by APD & are displayed on sampling oscilloscope.

Beam Splitter used for triggering oscilloscope and for i/p pulse measurement.

After initial measurement of o/p pulse width, long fiber length maybe cut back to short length and measurement repeated in order to make effective i/p pulse width.

Method 2: Insertion or substitution method

Fiber dispersion is obtained from two pulse width measurements taken at any fraction of their amplitude

$$t_o^2(3db) = t^2(3db) + t_i^2(3db)$$

where  $t_i(3db)$  &  $t_o(3db)$  are 3db pulse widths at fiber  
 $t(3db)$  - width of fiber impulse response, i/p & o/p.

$$\text{Pulse dispersion } \tau(3db) = \frac{[t_o^2(3db) - t_i^2(3db)]^{1/2}}{L} \text{ ns/km}$$

2. Frequency domain Measurement:

- Base band frequency response  $H(\omega)$  obtained
- Bandwidth of fiber is obtained from this measurement

\* Replace sampling oscilloscope by spectrum analyser.



Comparison of Spectrum at fiber o/p  $O(\omega)$  with Spectrum at fiber i/p provides baseband frequency response for the fiber is  $H(\omega) = P_o(\omega) / P_i(\omega)$ .

\* Launch sinusoidally modulated optical signal at different frequencies using sweep oscillator.  $\therefore$  Signal energy is concentrated at narrow band in baseband region.

Swept frequency measurement method:

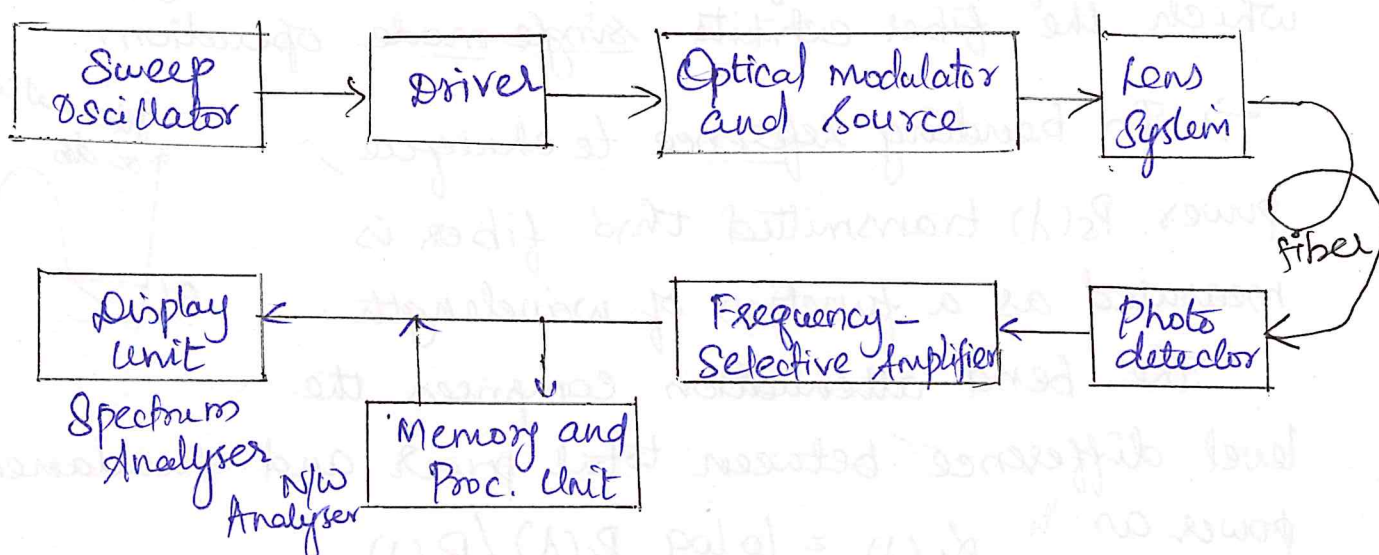

- Optical source is directly modulated from sweep oscillator
- Spectrum analyser obtains continuous display of swept frequency signal.
- Spectrum analyser provides no information on phase of received signal
- Network analyser employs both freq. & phase information.

When optical signal with freq.  $f_m$  is transmitted thro' fiber (length  $L$ ), then modulation envelope is delayed by,  $L/v_g = \tau_g L$ .  $v_g$  - group velocity

Delay of one modulation period  $T_m = 1/f_m$  corresponds to phase shift of  $2\pi$ , then modulation is shifted by an angle  $\phi_m$  where:

$$\phi_m = 2\pi f_m \tau_g L \quad \therefore \tau_g = \phi_m / 2\pi f_m L$$



## Fiber Cutoff Wavelength Measurements:

Multimode fiber has many cutoff wavelengths.

$$\text{No. of guided modes } M = \left(\frac{\pi a}{\lambda}\right)^2 (n_1^2 - n_2^2) \quad \left[ \because M = \frac{V^2}{2} \right]$$

Wavelength is increased, no. of modes are cut off.

Cutoff wavelength of  $LP_{lm}$  mode is the maximum wavelength for which the mode is guided by the fiber.

~~Effective~~ Cutoff wavelength is shortest wavelength above which the fiber exhibits single mode operation.

→ In bending reference technique, power  $P_S(\lambda)$  transmitted thru fiber is measured as a function of wavelength.

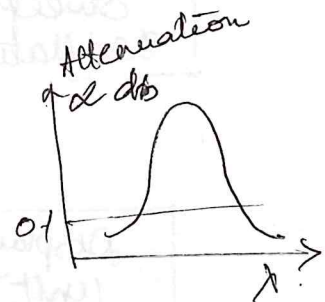

The bend attenuation comprises the level difference between total power and fundamental power as:

$$\alpha_b(\lambda) = 10 \log_{10} P_S(\lambda) / P_B(\lambda)$$

Effective cutoff wavelength is determined as the longest wavelength at which bend attenuation  $\alpha_b(\lambda)$  equals 0.1 db.

The relative attenuation  $\alpha_m(\lambda)$  between the powers launched into multimode and single mode fibers may be computed as:

$$\alpha_m(\lambda) = 10 \log_{10} P_S(\lambda) / P_{SM}(\lambda)$$

→ To find effective  $\lambda_c$  is the measurement of spot size with wavelength. Use transverse method, to measure spot size as a function of wavelength. In single mode fiber, spot size increases linearly with increasing wavelength.



## Fiber Numerical Aperture Measurements:

Numerical aperture - light gathering ability of fiber.

$$NA = \sin \theta_a = \sqrt{n_1^2 - n_2^2}$$

NA measurement performed by,

- \* directly measuring far field angle from a fiber using
- \* calculating far field angle using trigonometry <sup>rotating stage</sup>.

*Method* ① → The fiber off end is positioned on a rotating stage with its end face parallel to plane of detector i/p and o/p is perpendicular to the axis of rotation.

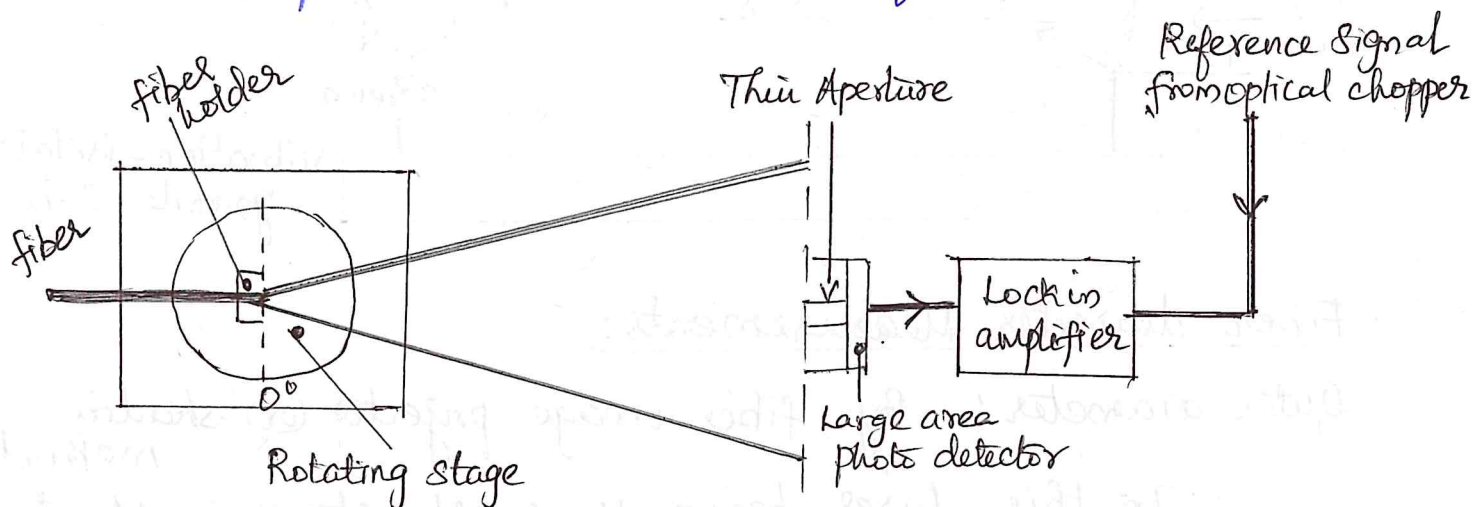

→ The photo detector is placed 10 or 20 cm from fiber & positioned to obtain max. signal with no rotation (0°). When the rotating stage is turned the limits of far-field pattern may be recorded.

→ The o/p power is monitored and plotted as a function of angle, max. acceptance angle is obtained when power drops to 5% of max. intensity. Thus, numerical aperture can be obtained.

*Method* ② → The end prepared fiber is beated on an optical base plate or slab. Light is launched into fiber under test & far field pattern from fiber is displayed



on a screen which is positioned a known distance  $D$  from fiber's end face. The test fiber is aligned so that optical intensity on the screen is maximized.

Finally, the pattern size on the screen  $A$  is measured using vernier caliper. The NA is obtained from simple trigonometrical relationships where:

$$NA = \sin \theta_a = \frac{A/2}{[(A/2)^2 + D^2]^{1/2}} = \frac{A}{(A^2 + 4D^2)^{1/2}}$$

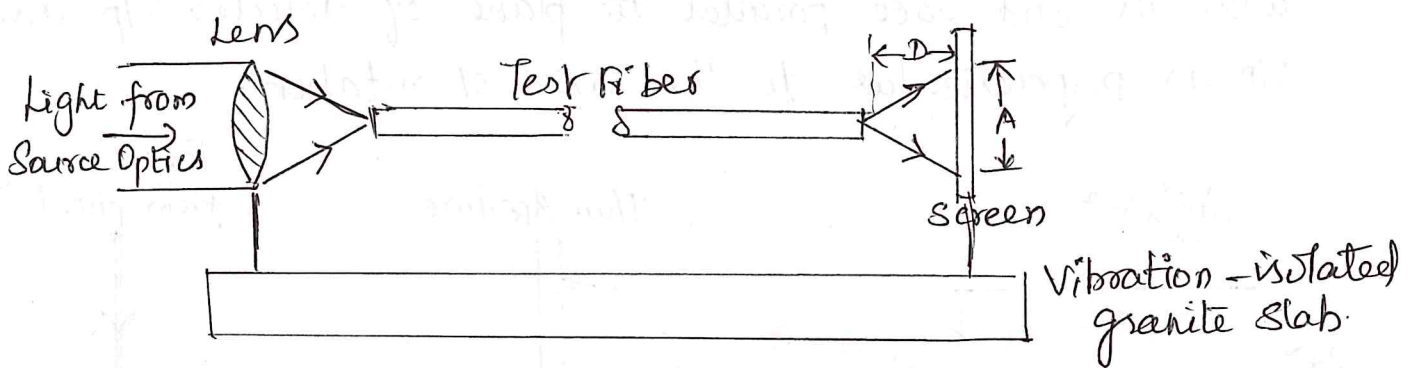

### Fiber diameter Measurements:

Outer diameter :- By fiber image projector (or) shadow method.

In this, laser beam is swept at a constant velocity & measurement is made of time interval during which fiber intercepts beam & casts a shadow on a photo detector.

The laser beam is collimated using two lenses ( $G_1$  &  $G_2$ ). It is reflected off two mirrors ( $M_1$  &  $M_2$ ),  $M_2$  is driven by galvanometer. Laser beam is focused by lens ( $G_3$ ) is swept across fiber by oscillating mirror, and is incident on photo detector unless it is blocked by the fiber.



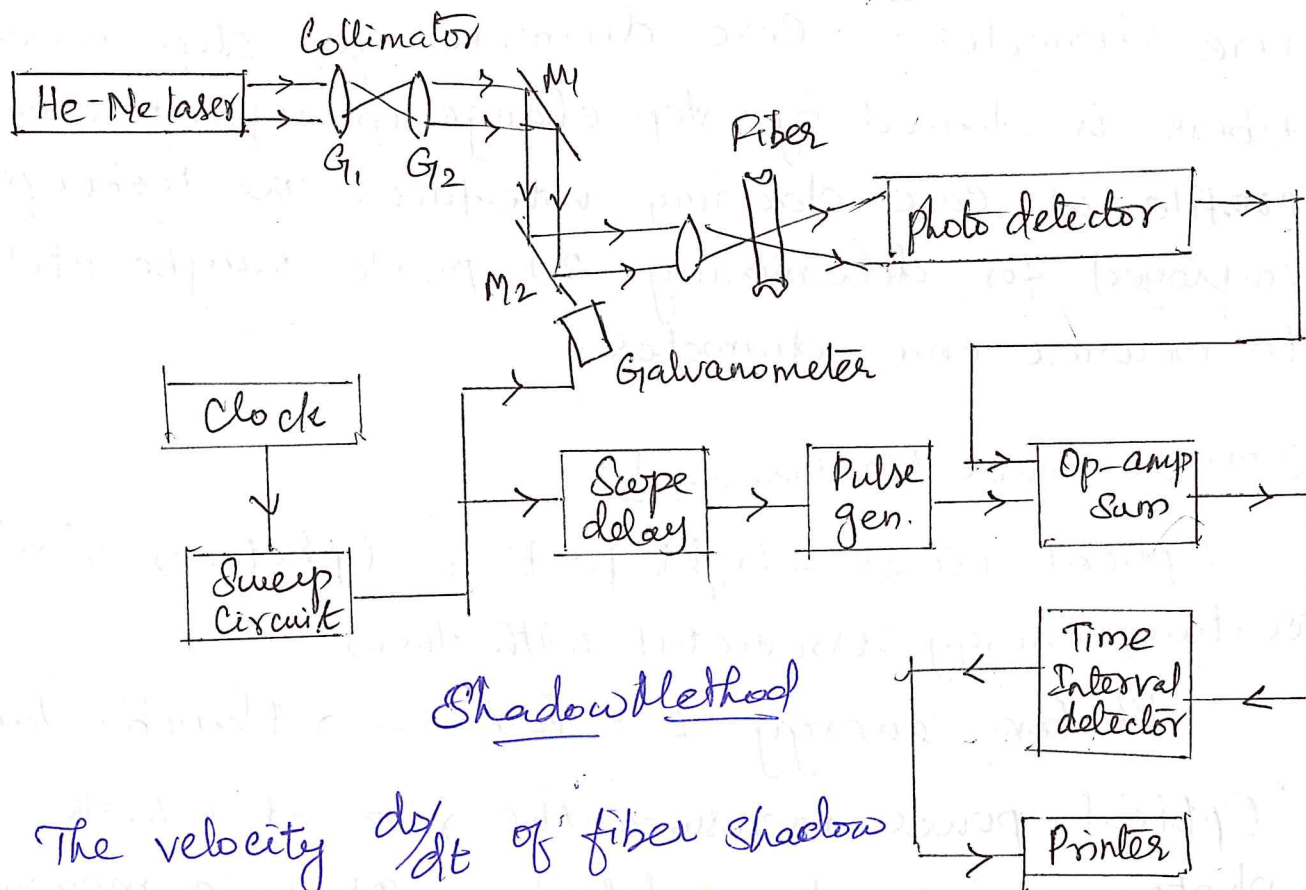

### Shadow method

The velocity  $\frac{ds}{dt}$  of fiber shadow is directly proportional to mirror velocity  $\frac{d\theta}{dt}$ , (ie)  $\frac{ds}{dt} = l \frac{d\theta}{dt}$ ;  $l$  - distance between mirror & photodetector

The shadow is registered by photodetector as an electrical pulse width  $W_e$  which is related to fiber outer diameter  $d_o$  as:  $d_o = W_e \frac{ds}{dt}$ .

Fiber outer diameter may be determined and recorded on printer.

Ex: In shadow method, rotating error with angular velocity  $4 \text{ rad/s}$ , which is located  $10 \text{ cm}$  from photo detector. Shadow pulse of width  $300 \mu\text{s}$  is registered by photo detector. Find outer diameter of fiber

$$\text{Shadow velocity } \frac{ds}{dt} = l \frac{d\theta}{dt} = 0.1 \times 4 = 0.4 \text{ m/s} = 0.4 \mu\text{m}/\mu\text{s}$$

$$\text{Fiber outer diameter } d_o = W_e \frac{ds}{dt} = 300 \mu\text{s} \times 0.4 \mu\text{m}/\mu\text{s} = 120 \mu\text{m}$$



Core diameter: Core diameter for step index fibers is defined by step change in refractive index profile at core-cladding interface. The techniques employed for determining RI profile may be utilized to measure core diameter.

### Optical Power Measurement:

Optical power - light particles (photons) have certain energy associated with them.

Photon energy  $E = h\nu$  → Planck's law

\* Optical power measures the rate at which photons arrive at a detector. It is a measure of energy transfer per time.

\* Radiance (brightness) is a measure of how much optical power radiates into designated solid angle per unit of emitting surface.

Two Standard classes of power measurements:

Peak power - Maximum power level in a pulse

Average Power - Measure of power level averaged over long time period.

Optical Power meter - Function of this is to measure total power over a selected wavelength band.

Multiwavelength optical power meters using photo detectors are most common instrument for measuring optical signal power levels.



## Source to fiber power launching:

Launching optical power from a source into fiber entails considerations such as numerical aperture, core size, RI profile and core-cladding index difference of the fiber plus the size, radiance and angular power distribution of optical source.

A measure of amount of power emitted from a source that is coupled into fiber is given by coupling efficiency  $\eta = P_f/P_s$ .

$P_f$  - Power Coupled into the fiber.

$P_s$  - Power emitted from the light source.

Coupling efficiency depends on type of fiber.

Measure of optical output of luminescent source is radiance (brightness). Radiance is a measure of how much optical power radiates into solid angle per unit of emitting surface.

Source output pattern: To determine optical power capability radiation pattern of source must be known.

Surface emitting LED is characterized by Lambertian pattern. Lambertian source follows the relationship pattern from an optical source  $B(\theta, \phi) = B_0 \cos \theta$

where  $B$  is the radiance along normal to the radiating surface.

Edge emitting LEDs & laser diodes have more complex radiation pattern.



Power launching Vs Wavelength :

Optical power launched into fiber doesn't depend on wavelength but only brightness.

No. of modes  $M = \left(\frac{2\pi a n_1}{\lambda}\right)^2 \Delta \left[\frac{\alpha}{\alpha+2}\right]$  in graded index fiber  
 $\alpha$  - Index profile.

Radiated power per mode  $P/M$ , from a source at a particular wavelength is radiance multiplied by square of nominal source wavelength.  $P/M = B_0 \lambda^2$ .

Fiber flylead - couple source to fiber  
- has identical NA & core diameter  
- to achieve low coupling loss.

If light emitting area is less than cross section area of fiber core, power coupled into fiber is given by NA.

Lensing Scheme for Coupling Management:

→ If source-emitting area is larger than fiber-core area, then resulting optical power coupled into fiber is maximum.

→ If source-emitting area is smaller than core area, a miniature lens maybe placed between source and fiber to improve power-coupling efficiency.

→ The function of microlens is to magnify the emitting area of source to match the core area of fiber

Lensing Schemes: Rounded-ended fiber,  
Small glass sphere (non imaging microspheres),  
Cylindrical lens  
Spherical ended fiber  
Taper-ended fiber.

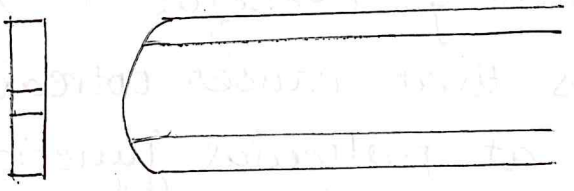
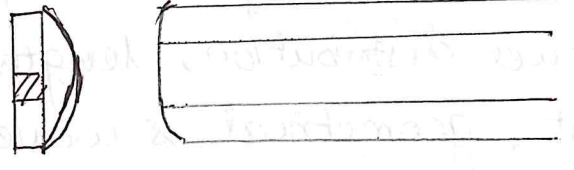
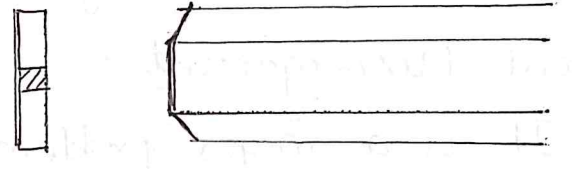
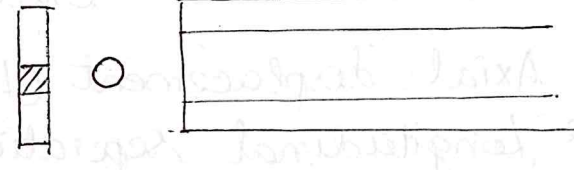
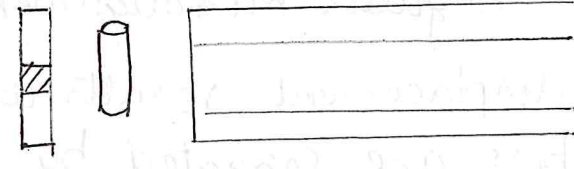
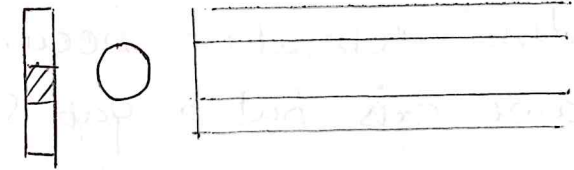

1. Rounded-end fiber 
2. Spherical-Surface LED Spherical ended fiber 
3. Taper-ended fiber 
4. Non-imaging micro sphere 
5. Cylindrical lens 
6. Imaging Sphere 

### Fiber to fiber Joints:

A significant factor in optical systems installation is the requirement to interconnect fibers in a low loss manner.

The technique selected for joining the fibers depend on whether permanent bond or demountable connection. A permanent bond is known as Splice, whereas demountable joint is known as Connector.



Every joining technique is subject to certain conditions that causes optical power loss at the joint. The loss at particular junction is called insertion loss.

These losses depend on parameters such as input power distribution, length of fiber between source and joint, geometrical & waveguide characteristics of two fiber ends at the joint.

Mechanical Misalignment:

- It is a major problem when joining two fibers.
- Radiation losses result from mech. misalignment.

Types:

1. Axial displacement (Lateral displacement)
2. Longitudinal separation
3. Angular misalignment.

Axial displacement results when the axes of two fibers are separated by a distance  $A$ .

Longitudinal separation occurs when the fiber have same axis but a gap  $S$  between their end faces.

Angular misalignment results when the axes forms an angle so that the fiber end faces are no longer parallel.

The most common misalignment which causes greatest power loss is Axial displacement

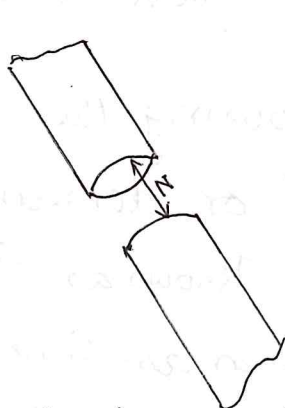

a) Longitudinal

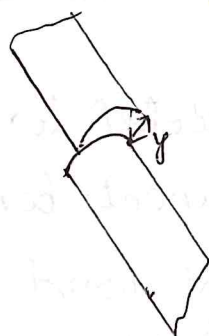

b) lateral

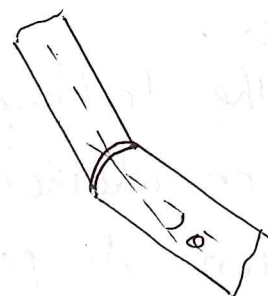

c) Angular



## LED Coupling to Single mode Fibers:

In earlier, LEDs were considered only for multimode fiber systems. Around 1985, researchers recognized that edge-emitting LEDs launch power into single mode fiber for transmission at 560 Mb/s data rate. Edge emitting LEDs are used for these applications because they have laser like output pattern in the direction perpendicular to junction plane.

To evaluate coupling between LED and a single mode laser, analyze two cases:

- 1) Direct coupling of LED to single mode fiber.
- 2) Coupling into single mode fiber from multimode flylead attached to LED.

Edge emitting LEDs have gaussian near field o/p profiles in the directions perpendicular & parallel to the junction plane. Far field patterns vary as  $\cos^2 \theta$  in the perpendicular direction and  $\cos \theta$  (Lambertian) in the parallel direction.

Max. LED to fiber coupling efficiency  $\eta = P_{in}/P_s$ .

where  $P_{in}$  - optical power launched into fiber.

$P_s$  - Total source output power.

## Fiber Splicing:

A permanent joint between two individual optical fibers is known as fiber splice.

It is used to establish long haul optical links where smaller fiber lengths need to be joined.



## Categories of Splices :

1. Fusion Splicing or welding
2. Mechanical splicing

Fusion Splicing is accomplished by applying localized heating (by flame or electric arc) at the interface between two butted, prealigned fiber ends causing them to soften and fuse.

Mechanical splicing in which fibers are held in alignment by some mechanical means, may be achieved by various methods including the use of tubes around fiber ends (tube splices) or V-grooves into which the butted fibers are placed.

### Fusion Splices:

It involves the heating of two prepared fiber ends to their fusing point with application of axial pressure between fibers. Fiber ends are positioned and aligned to achieve good continuity of transmission medium at junction. Hence, these fibers are positioned and clamped with aid of microscope.

Flame heating sources such as microplasma torches (argon &  $H_2$ ) and oxyhydrolic microburners (oxygen,  $H_2$  and alcohol vapor) have been utilized.

The most widely used heating source is an electric arc. This technique offers advantages of consistent, easily controlled heat with adaptability for use under field conditions.



## Optical Fiber Connectors:

Demountable fiber connectors are difficult to achieve than splices. This is because they maintain tolerance requirements to splices. Connectors allow for repeated connection or disconnection without problems of fiber alignment which leads to degradation.

In order to maintain performance, connection protects fiber ends from damage which occur due to handling (connection & disconnection), must be insensitive to environmental factors (ex. moisture & dust) & must cope with tensile load of cable.

Connectors maybe considered in major three areas which are:

- a) Fiber termination, which protects fiber ends;
- b) Fiber end alignment to provide optimum coupling;
- c) the outer shell, which maintains connection & fiber alignment, protects fiber ends from environment and provides adequate strength at the joint.

Categories:

- 1) Butt-jointed Connectors
- 2) Expanded beam Connectors.

Butt-jointed Connectors rely upon alignment of two prepared fiber ends in close butted to each other so that fiber core-axes coincide.

Expanded beam Connectors utilize interposed optics at joint in order to expand beam from transmitting fiber, before reducing it to a size compatible with receiving fiber end.



## Mechanical Splices:

A common method involves the use of an accurately produced rigid alignment tube into which the prepared fiber ends are permanently bonded.

Snug splice tube utilizes a glass or ceramic capillary with an inner diameter large enough to accept optical fibers. Transparent adhesive (Epoxy resin) is injected thro' a transverse bore in the capillary to give mechanical seating and index matching of the splice. Average insertion loss 0.1 db obtained from multimode & SM fibers.

Loose tube splice uses an oversized square-section metal tube which accepts prepared fiber ends. Transparent adhesive is first inserted into tube followed by the fibers. The splice is self-aligning when fibers are curved in same plane, forcing fiber ends into the same corner of the tube. Mean splice insertion losses of 0.073 db is achieved in multimode graded index fibers with loose tube approach.

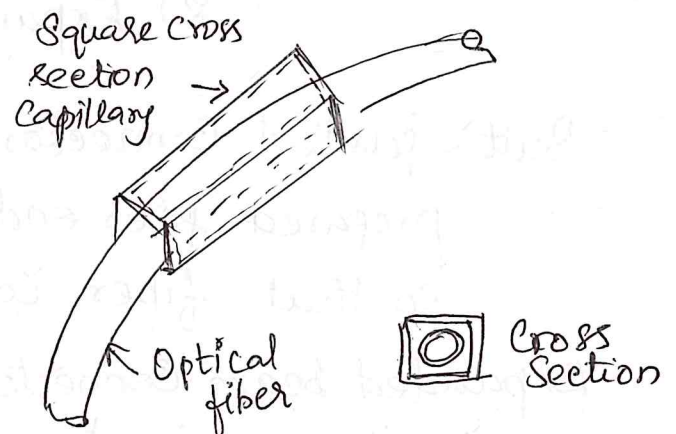
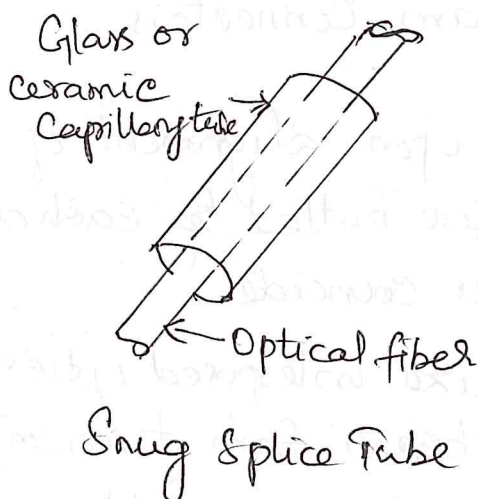



## Cylindrical Ferrule Connectors:

The basic ferrule connector is the simplest optical fiber connector design. The two fibers to be connected are permanently bonded in metal plugs known as ferrules which have drilled central hole in their end faces where fiber is located. The fiber end faces must be smooth and square. This may be achieved by

- 1) cleaving the fiber before insertion into ferrule.
- 2) inserting & bonding before cleaving the fiber close to the ferrule end face.
- 3) using either ① or ② and polishing fiber end face until it is flush with the end of ferrule.

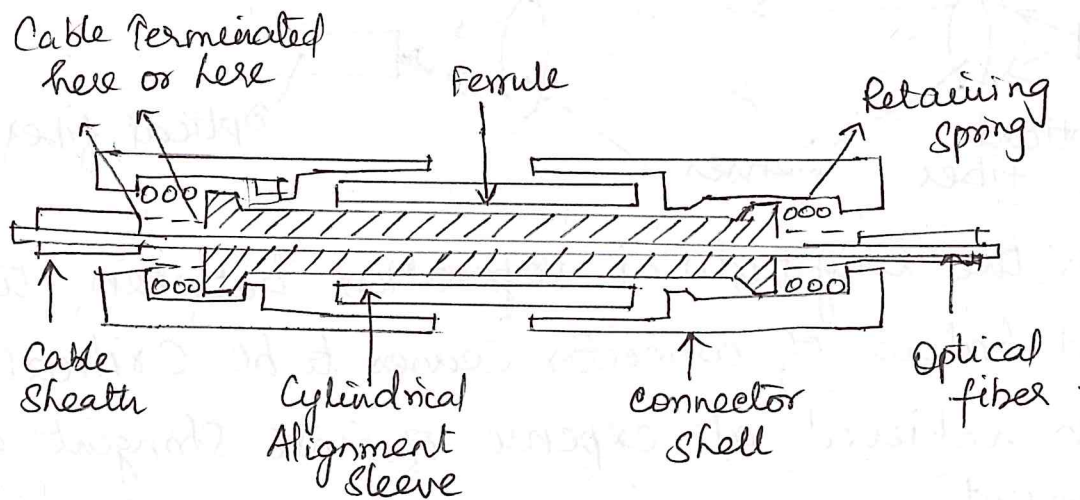

## Duplex and Multiple-fiber Connectors:

Duplex fiber - two way communication.

- Used in Fiber Distributed Data Interface.
- Comprised two ST ferrules housed in a protective molded shroud
- Insertion loss 0.6 db.
- Simple one

Multiple fiber - Interconnect large no. of fibers



Both cylindrical and biconical ferrule connectors can be assembled in housings to form multiple-fiber configurations. Multiple biconical ferrule connectors have low insertion force of the biconic configuration.

### Expanded beam Connectors:

A connector consists of two lenses for collimating and refocusing the light from one fiber into the other. The use of these interposed optics makes the achievement of lateral alignment much less critical than with a butt-jointed connector.

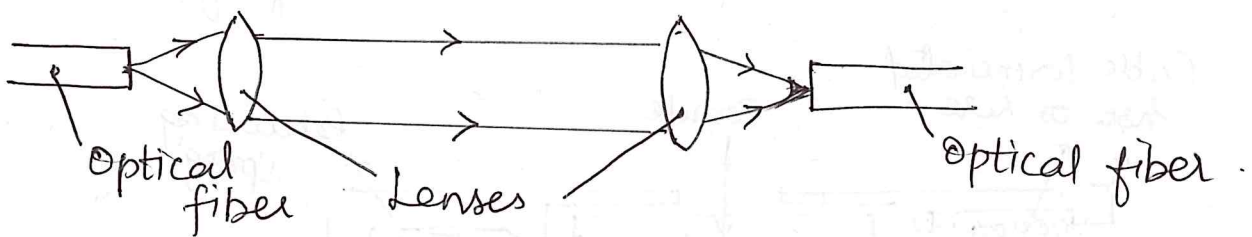

Also, the longitudinal separation between two mated halves of connector ceases to be critical. This is achieved at expense of more stringent angular alignment.

The expanded beam connectors are useful for multi fiber connection and edge connection for PCBs where lateral and longitudinal alignment are frequently difficult to achieve.



Lens coupled expanded beam connector utilized spherical microlens for beam expansion and reduction.

It exhibited average loss of 1db which is reduced to 0.7 db with the application of antireflection coating on the lenses & use of graded index fibers of 50  $\mu\text{m}$  core diameter.

In second type of expanded beam connector which employs molded spherical lens. The fiber is positioned at focal length of lens in order to obtain a collimated beam and minimize lens-to-lens longitudinal misalignment effects.

A lens alignment sleeve is used to minimize the effects of angular misalignment which together with ferrule, spring & housing, provides complete connector structure. Insertion loss 0.7 db.

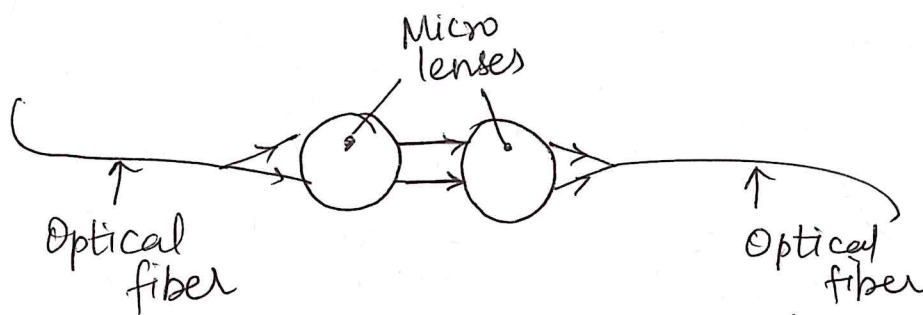

Lens Coupled expanded beam connector.

An array of microlenses used to connect several fibers simultaneously. An assembly where two arrays of microlenses are employed to interconnect two arrays of fibers.



It displays a multi fiber connector assembly in which fibers are placed onto a tray of V-grooves inside the adaptor by mechanical fixture which provides permanent bond. This multifiber connector can be inserted into an adaptor containing two arrays of microlenses.

The microlens arrays translate divergent beams from optical fibers into collimated beams and viceversa. Optical coupling losses remain under 1db for multimode fibers and 0.5 db for single mode fiber arrays.

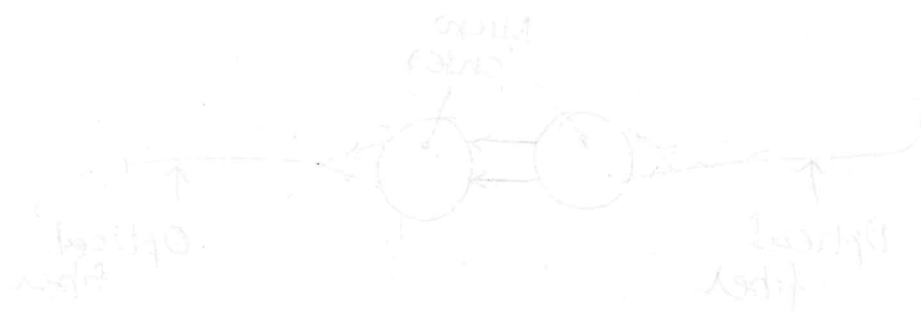



## Problems.

- 1) A 2km length of multimode fiber is attached to apparatus for Spectral loss measurement. Measured o/p volt. from photo receiver using 2km length fiber is 2.1 V at  $\lambda = 0.85 \mu\text{m}$ . When fiber is cutback to leave a 2 km length o/p increases to 10.7 V. Find att./km for fiber at  $\lambda = 0.85 \mu\text{m}$ .

$$\alpha_{\text{db}} = \frac{10}{l_1 - l_2} \log_{10} \frac{V_2}{V_1} = \frac{10}{1.998} \log_{10} \frac{10.7}{2.1} = 3.5 \text{ db/km.}$$

- 2) Measurements are made using calorimeter & thermocouple arrangement to determine absorption loss. Initially, high absorption fiber is utilized to obtain a plot of  $(T_{\infty} - T_1)$  on a log. scale against time. From plot, readings of  $(T_{\infty} - T_1)$  after 10 & 100s are 0.525 & 0.021 mV resp. Max. rise temp. are  $0.525$  &  $0.021 \mu\text{V}$   $4.3 \times 10^{-4} \text{ } ^\circ\text{C}$  with const measured opt. power of 98mW at  $\lambda = 0.75 \mu\text{m}$ . Thermal Capacity  $1.64 \times 10^4 \text{ J}$ .

$$t_c = \frac{t_2 - t_1}{\ln(T_{\infty} - T_{t_1}) - \ln(T_{\infty} - T_{t_2})}$$
$$= \frac{100 - 10}{\ln(0.525) - \ln(0.021)} = 28 \text{ s}$$

$$\text{Absorption loss } \alpha_{\text{abs}} = \frac{c T_{\infty}}{P_{\text{opt}} t_c} = \frac{1.64 \times 10^4 \times 4.3 \times 10^{-4}}{98 \times 10^{-3} \times 28} = 2.6 \text{ db/km}$$

- 3) A He-Ne laser operates at  $\lambda = 0.63 \mu\text{m}$  was used with solar cell to measure scattering loss with const opt. power. Reading from solar cell tube was 6.14 mV. Opt. power at cube without scattering was 153.38  $\mu\text{W}$ . Length of fiber is 2.92 cm. Find loss due to scattering in db/km of fiber.

$$\alpha_{\text{sc}} = \frac{4.343}{L(\text{km})} \left( \frac{P_{\text{sc}}}{P_{\text{opt}}} \right) \text{ db/km}$$
$$= \frac{4.343}{2.92 \times 10^{-2}} \times 10^3 \left( \frac{6.14 \times 10^9}{153.38 \times 10^{-6}} \right) = 6 \text{ db/km}$$



4) Pulse dispersion measurements are taken over 1.2 km length of fiber. 3db width of i/p pulses are 300ps & corresponding 3 db widths for o/p pulses are 12.6 ns

Find i) 3 db pulse broadening of fiber ii) Fiber BW-length product.

$$\tau_{3db} = \frac{[\tau_o^2(3db) - \tau_e^2(3db)]^{1/2}}{L} \text{ ns/km}$$

$$= \frac{(12.6^2 - 0.3^2)^{1/2}}{1.2} = 10.5 \text{ ns/km}$$

$$B_{opt} = \frac{0.44}{\tau_{(3db)}} \text{ GHz} = \frac{0.44}{10.5} \text{ GHz km} = 41.9 \text{ MHz km}$$

5) A trigonometric measurement is performed to find NA of step index fiber. The screen is positioned 10 cm from fiber end, when illuminated from a source o/p pattern size is 6.2 cm. Find NA.

$$NA = \frac{A/2}{\sqrt{(A/2)^2 + D^2}} = \frac{6.2/2}{\sqrt{(6.2/2)^2 + 10^2}} = 0.3$$



## Unit V. Optical Communication Systems and Networks.

### System Design Consideration:

In optical system design major consideration involves

1. Transmission characteristics of fiber (attenuation + dispersion).
2. Information transfer capability of fiber.
3. Terminal equipment & Technology.
4. Distance of transmission.

An optical communication system has following required specifications.

- Transmission type (Analog / Digital).
- System fidelity (SNR / BER)
- Required transmission bandwidth
- Acceptable repeater spacing.
- Cost of system.
- Reliability
- Cost of maintenance.

### System consideration:

\* Before selecting components, operating wavelength for the system is decided. The operating wavelength selection depends on distance & attenuation. For shorter distance, 800-900 nm region is preferred but for long distance 100 or 1550 nm region is preferred due to lower attenuation & dispersion.

\* Consider the following factors to select photo detector, → complexity of circuit



→ cost of design

→ biasing requirements etc.

\* Next step, choose proper optical source. Important factors to select source are,

→ Signal dispersion

→ data rate

→ Transmission distance

→ cost & circuit complexity.

\* Last factor, selection of optical fibers: Factors are,

→ Numerical Aperture increases, fiber coupled power increases, dispersion becomes greater.

→ Environment induced losses ex: due to moisture etc.

→ Attenuation characteristics, excess loss results from cabling process.

### Point-to-Point link:

The simplest transmission link is point-to-point line that has transmitter on one end & receiver at one end.

\* Distance of transmission

\* channel data rate

\* Bit-error rate

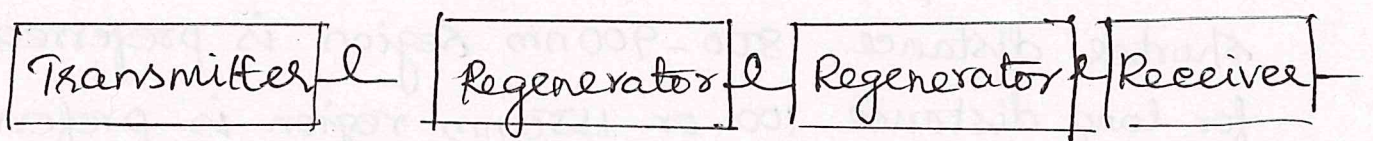

To fulfill these requirements, designer has a choice of the following components and their associated characteristics:



1. Multimode or Single-mode Optical fiber:

- a) core size
- b) core R-I profile
- c) bandwidth
- d) attenuation
- e) Numerical aperture.

2. LED or Laser diode Optical Source:

- a) Emission wavelength
- b) spectral linewidth
- c) Output power
- d) Effective radiative area
- e) Emission pattern.

3. Pin or Avalanche photodiode.

- a) Responsivity
- b) Operating wavelength
- c) speed
- d) sensitivity.

Two important analysis for deciding performance of any fiber link are-

- i) link power budget / Power budget
- ii) Rise time budget / Bandwidth budget.

Link Power Budget:

- determines the power margin between optical transmitter output and min. receiver sensitivity to establish BER. The optical power received at photo detector depends on amount of light coupled into fiber and losses in fiber end at connectors & splices.



Let  $l_c$  denotes the losses occur at connector.

$l_{sp}$  denotes losses occur at splices

$\alpha_f$  denotes losses occur in fiber.

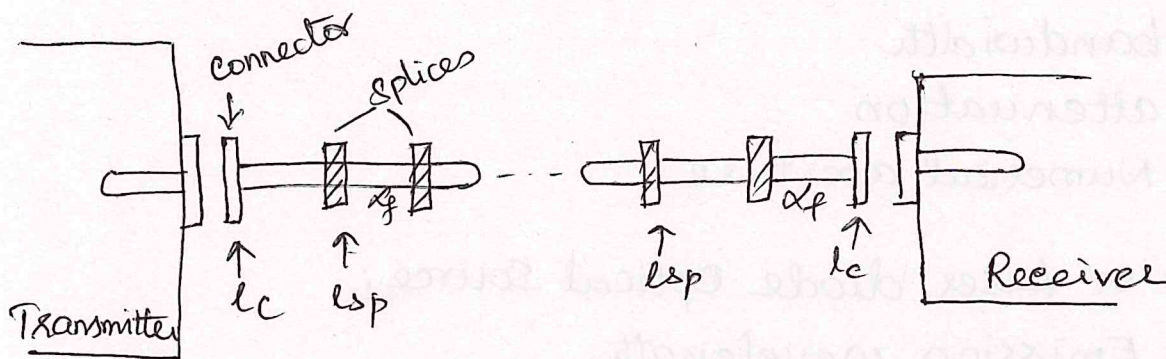

Link power margin considers the losses due to component aging & temp. fluctuations.

Total optical loss = Connector loss + (Splicing loss + Fiber attenuation) + System margin ( $P_m$ )

$$P_T = 2l_c + \alpha_f L + \text{System margin } (P_m) \text{ where } L - \text{transmission distance}$$

### Rise time Budget:

Rise time gives important information for initial system design. Rise-time budget analysis determines the dispersion limitation of an optical link.

Total risetime of a fiber link is the root-sum-square of rise time of each contributor  $t_{ri}$  to the pulse time degradation.

$$t_{sys} = \sqrt{t_{r1}^2 + t_{r2}^2 + \dots}$$
$$= \left( \sum_{i=1}^N t_{ri}^2 \right)^{1/2}$$

Risetime and fall time determines overall response time and the resulting bandwidth.



Connectors, couplers and splices don't affect system speed, they need not be accounted in rise time budget but they appear in link power budget.

Four basic elements that contribute to rise-time are, Transmitter rise-time ( $t_{tx}$ ), Group velocity Dispersion rise time ( $t_{GVD}$ ), modal dispersion rise time of fiber ( $t_{mod}$ ), Receiver rise time ( $t_{rx}$ ).

$$t_{sys} = [t_{tx}^2 + t_{mod}^2 + t_{GVD}^2 + t_{rx}^2]^{1/2}$$

Single mode fibers don't experience modal dispersion, so in this risetime is related to GVD.

Rise time due to modal dispersion is

$$t_{mod} = \frac{440}{B_m} = \frac{440 L q}{B_0}$$

where,  $B_m$  - Bandwidth (MHz)

$L$  - length of fiber (km)

$q$  - parameter ranging between 0.5 & 1

$B_0$  - bandwidth of 1km length fiber

Rise time due to group velocity dispersion is

$$t_{GVD} = D^2 \sigma_\lambda^2 L^2$$

where  $D$  is Dispersion

$\sigma_\lambda$  is half-power spectral width of source.

$L$  is length of fiber.

The risetime of transmitters and receivers are known to the designer. The transmitter risetime is to the light source & its drive circuit. Receiver rise time results from photo detector & 3-db electrical bandwidth of receiver front end.



Receiver front-end rise time (10 to 90% rise time) in ns is

$$t_{rx} = \frac{350}{B_{rx}} \quad \text{where } B_{rx} \text{ is 3db - BW of receiver}$$

Rise time equation  $t_{sys} = [t_{tx}^2 + t_{mod}^2 + t_{GVD}^2 + t_{rx}^2]^{1/2}$

$$t_{sys} = \left[ t_{tx}^2 + \left( \frac{140LQ}{B_0} \right)^2 + D^2 \sigma_1^2 L^2 + \frac{350}{B_{rx}} \right]^{1/2}$$

### WDM (Wavelength Division Multiplexing):

- This is the technology of combining a number of wavelengths onto the same fiber simultaneously. Each optical channel can carry any transmission format. WDM increases the capacity of a fiber network.

- WDM uses a multiplexer at the transmitter to joint the several signals together. It uses a demultiplexer at the receiver to split them.

- First, WDM systems combined only two signals. Modern systems can handle upto 160 signals and can expand a basic 10Gbit/s system over a single fiber pair to over 1.6Tbit/s. WDM systems can expand the capacity of network.

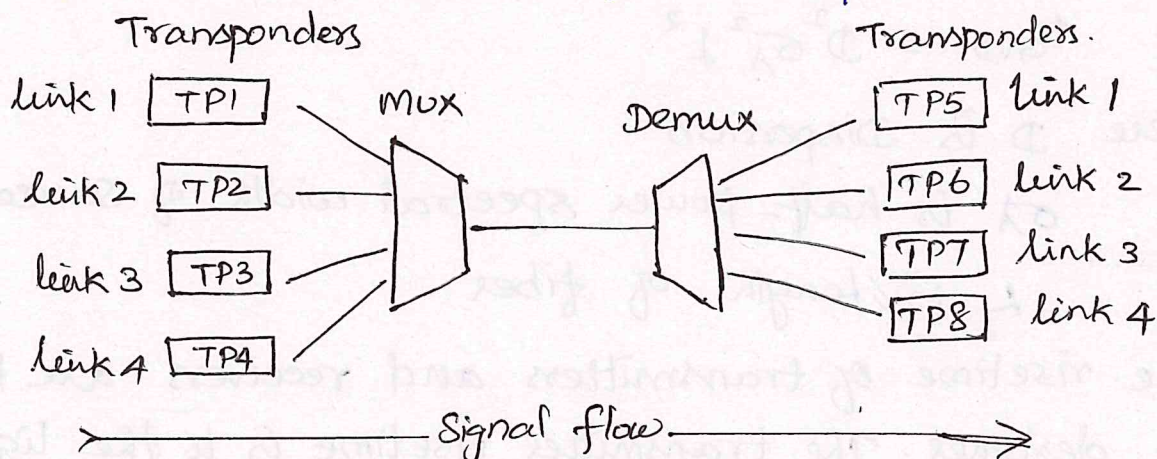



### Operational Principles of WDM:

Spectral width of high quality source occupies only a narrow slice of optical bandwidth, there are many independent operating regions across the spectrum can be used.

WDM uses a no. of light sources, each emits at a slightly different peak wavelength.

Each wavelength carries an independent signal, so that the link capacity is increased greatly. The main trick is to ensure that the peak wavelength of a source is spaced sufficiently. Designers include an empty guard band between the channels as safety factor.

WDM Operating Regions: DFB laser has a frequency spectrum on the order of 1MHz, spectral linewidth of 10-5nm. With such spectral widths, simplex system use only a tiny portion of transmission bandwidth capability of fiber.

The curve shows the attenuation of light in a silica fiber as a function of wavelength. The curve shows the two loss-loss regions. std G.652 sm fiber

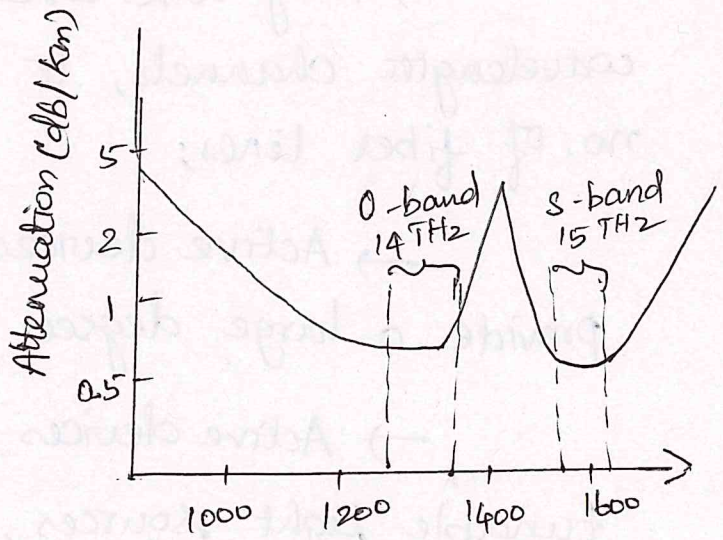



extend over O band wavelengths range from 1270 to 1350 nm (2<sup>nd</sup> window) and from 1480 to 1600 nm (3<sup>rd</sup> window). View these regions either in terms of spectral width & optical bandwidth.

To find optical bandwidth corresponding to a particular spectral width in these regions, fundamental relationship  $c = \lambda \nu$ .

$$\Delta \nu = \frac{c}{\lambda^2} \Delta \lambda$$

Frequency deviation  $\Delta \nu$ , wavelength deviation  $\Delta \lambda$ .

Generic WDM link:

WDM networks require passive/active devices to combine, distribute, isolate, add, drop, attenuate and amplify optical power at different wavelengths.

→ Passive devices require no external electric power for their operation.

→ They are used to separate or combine wavelength channels, to divide optical power onto a no. of fiber lines;

→ Active devices can be controlled electronically provide a large degree of n/w flexibility.

→ Active devices include tunable optical filters, tunable light sources, configurable add/drop mux, equalizers & amplifiers.



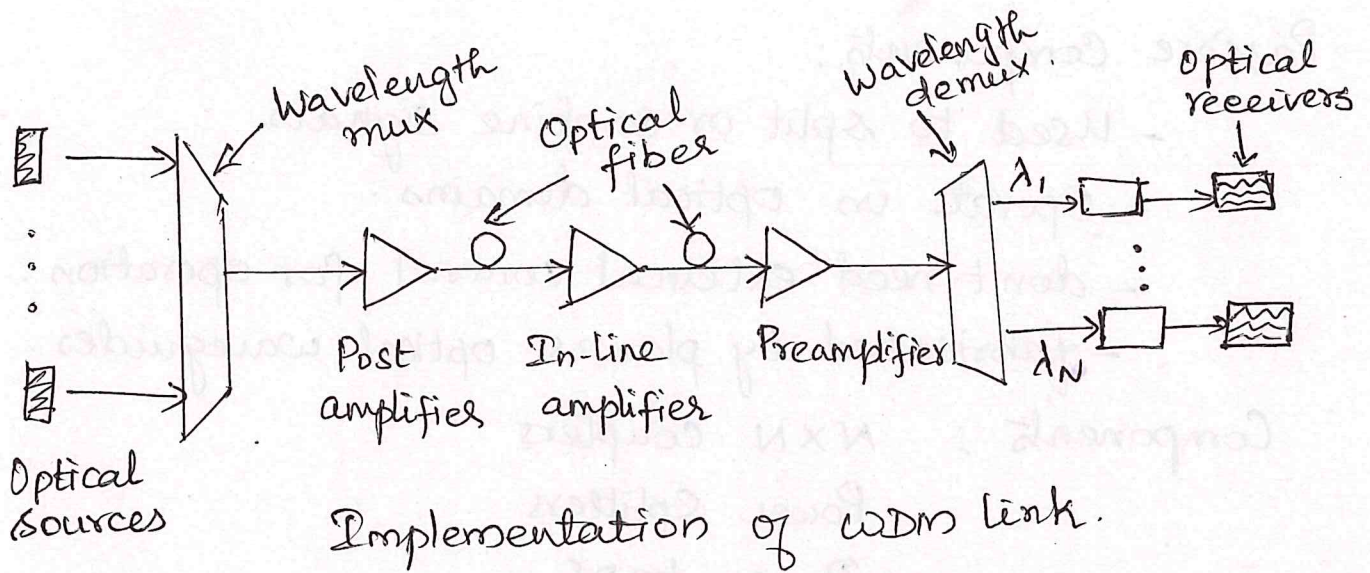

In fig., The transmitting side has a series of independently modulated fixed-wavelength light sources, each of which emits signals at unique wavelength.

Mux is used to combine optical outputs into continuous spectrum & couple them into fiber.

Various types of optical amplifiers, active components & power splitters are present.

At receiving end, demux is required to separate the individual wavelengths of independent optical signals for signal processing.

Features of WDM

- \* Capacity Upgrade - each wavelength supports independent data rate in Gbps.
- \* Transparency - WDM carries fast asynchronous, slow synchronous, synchronous analog + dig. data
- \* Wavelength routing - Link Capacity and flexibility be increased by multiple wavelengths
- \* Wavelength switching - WDM add or drop mux, cross



## Passive Components:

- Used to split or combine signals.
- Operate in optical domains.
- don't need external control for operation.
- fabricated by planar optical waveguides.

Components:  $N \times N$  couplers

Power Splitters

Power taps

Star couplers.

Star coupler is a multiple input & multiple output port device.

DWDM - Dense Wavelength Division Multiplexing):

- data transmission technology having very large capacity and efficiency.
- Multiple data channels are assigned different wavelengths, and are multiplexed onto one fiber.
- System consists of transmitters, mux, optical amplifier, demux.

Application: DWDM used single mode fiber to carry multiple light waves of different frequencies.

→ DWDM uses Erbium Doped Fiber Amplifiers (EDFA)

for its long haul applications, and to overcome the effects of dispersion and attenuation channel spacing of 100 GHz is used.



# DWDM System

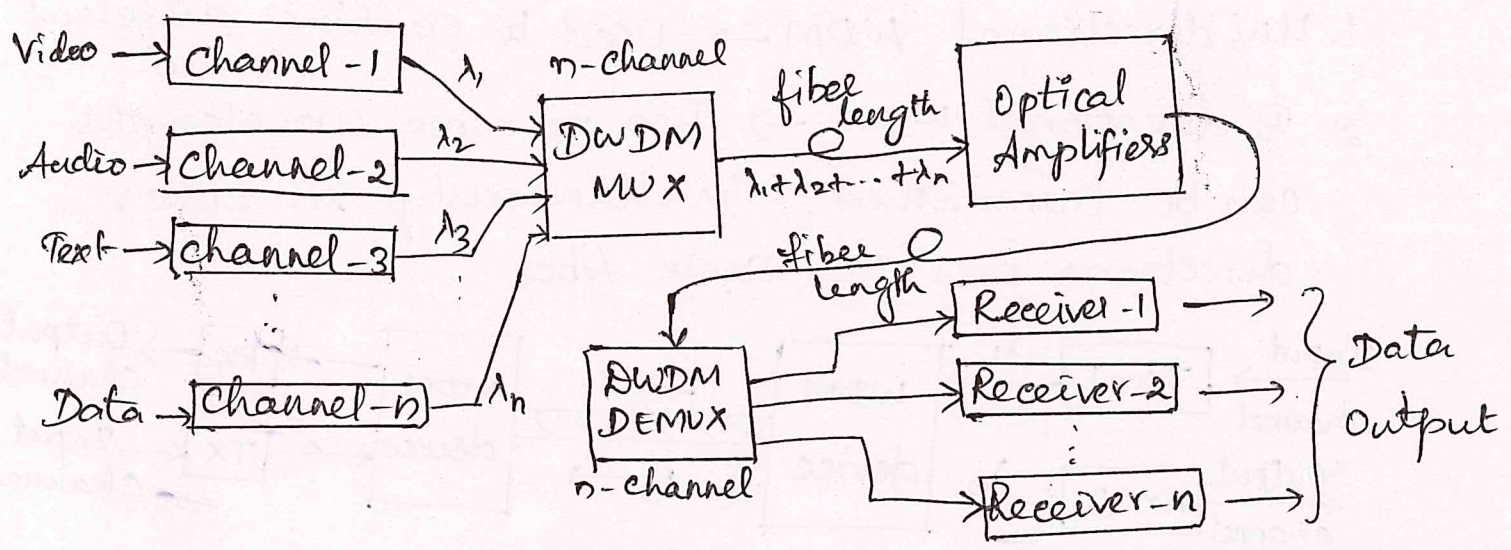

## Passive DWDM Components:

- Passive DWDM has no active components.
- The line functions due to optical budget of transceivers used.
- No optical amplifiers & dispersion compensators used.
- Passive DWDM has high channel capacity but transmission distance is limited to optical budget of transceivers used.

Application: → Used in metro networks  
 High speed lines with high channel capacity.

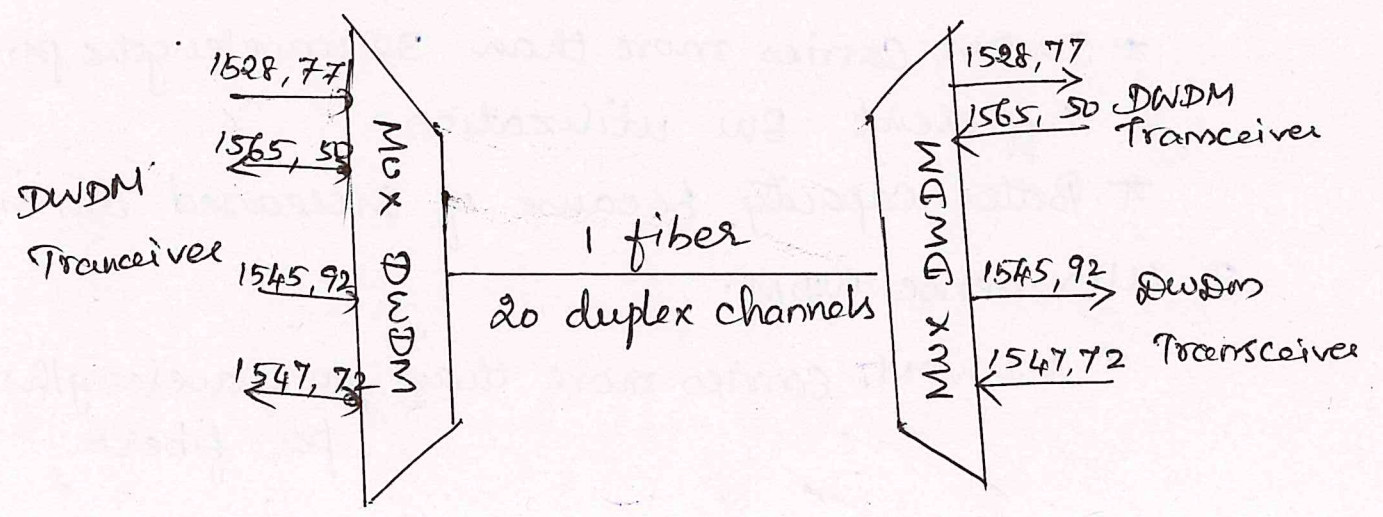



Types of WDM: 1. Unidirectional WDM  
2. Bidirectional WDM

1. Unidirectional WDM → Used to combine different source
2. Bidirectional WDM → Two or more wavelengths can be transmitted simultaneously in either directions over the same fiber.

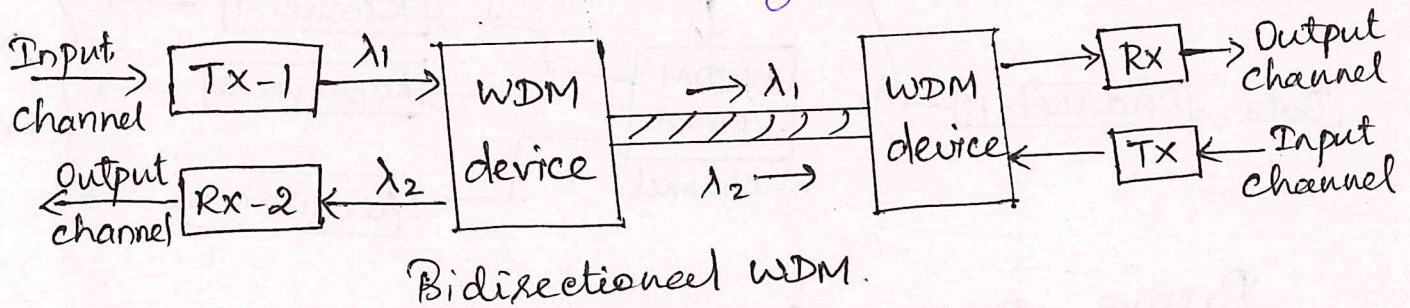

Categories of WDM: 1) Coarse WDM  
2) Dense WDM  
3) Ultra dense WDM

### 1. Coarse WDM :

- \* CWDM carries 4 to 16 wavelengths per fiber.
- \* No effective BW utilization as space between wavelengths are more.
- \* Amplification is difficult.
- \* Less cost.

### 2. Dense WDM :

- \* DWDM carries more than 32 wavelengths per fiber
- \* Efficient BW utilization
- \* Better capacity because of increased density.

### 3. Ultradense WDM :

- \* UDWDM carries more than 100 wavelengths per fiber.



## Elements of Optical Networks :

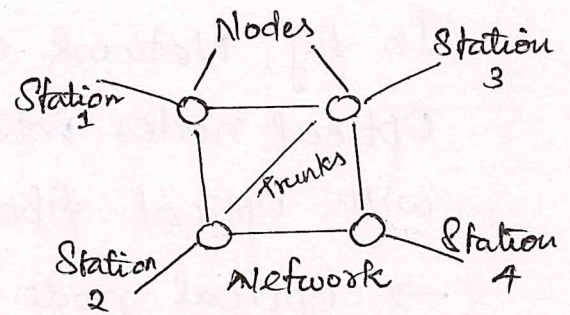

1. Stations : → Serve as source & destination of the information being transmitted and received.  
→ Devices used for communication such as computers, mobiles, data terminals etc.
2. Network : A group of interconnected devices. It allows to communicate with each other and share resources & information.
3. Node : It acts as hub for multiple transmission lines inside network. A common point where one or more data channels are terminated is called as node.
4. Topology : The way in which multiple nodes are connected together denotes topology of network.
5. Trunk : It is transmission line. A network is composed of multiple trunks for signal transmission over long distance.
6. Router : Device that routes data packets (provides suitable path for signal transmission) based on their logical addresses in interconnected networks.

## Optical network Concepts :

It is a transmission medium provides a connection between many users to communicate with each other by transporting information from source to destination.



In fig, Network consists of Optical nodes interconnected with optical fiber links.

→ Optical node is multi functional element which acts as a transceiver unit capable of receiving, transmitting and processing the optical signal.

→ A signal carried on a dedicated wavelength from source to a destination node is light path.

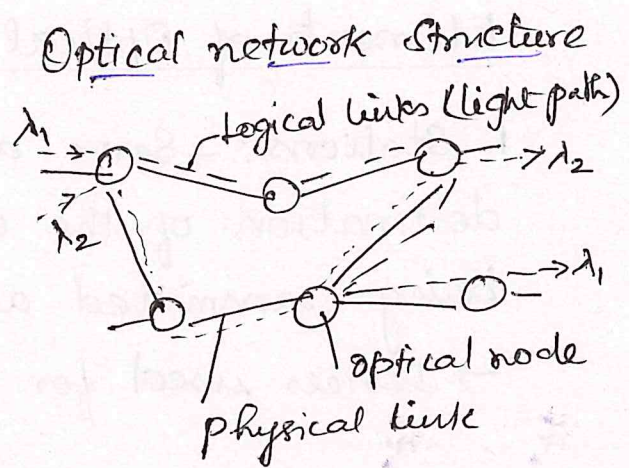

### Network Topologies:

1. Bus topology:
  - \* Data circulates bidirectionally.
  - \* Data can be accessed by station by optical couplers.
  - \* A single fiber cable carries multichannel optical signal. Distribution is done by using optical taps.
2. Ring topology:
  - \* Data circulates unidirectionally.
  - \* Consecutive nodes are connected by point to point links to form a closed ring.
3. Star topology:
  - All nodes are connected through point to point link to central node called hub.
  - \* An active hub controls all routing of messages in network from hub.

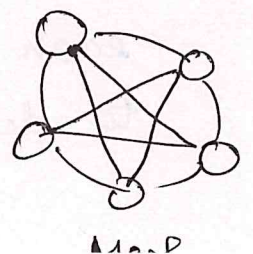
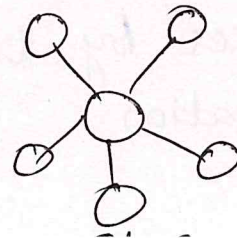
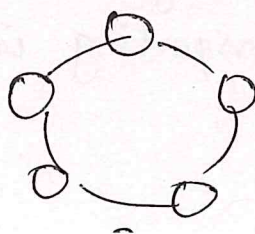
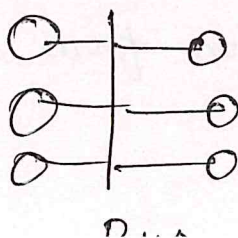



## Networking modes:

\* **Connection oriented** - End to end connection setup, referred as handshaking, is performed before the transmission takes place.

- It employs bidirectional communication environment to initiate connection between source & destination.

\* **Connectionless** - No dedicated end to end connection.

- No explicit connection setup is performed.

- Transmission is simply launched on a common fiber channel.

## SONET/SDH:

SONET - Synchronous Optical Network.

SDH - Synchronous Digital Hierarchy.

\* SONET is a communication protocol, developed by Bellcore.

\* Used to transmit large amount of data.

\* Multiple digital data streams are transferred at the same time over optical fibre.

## SONET Network Elements:

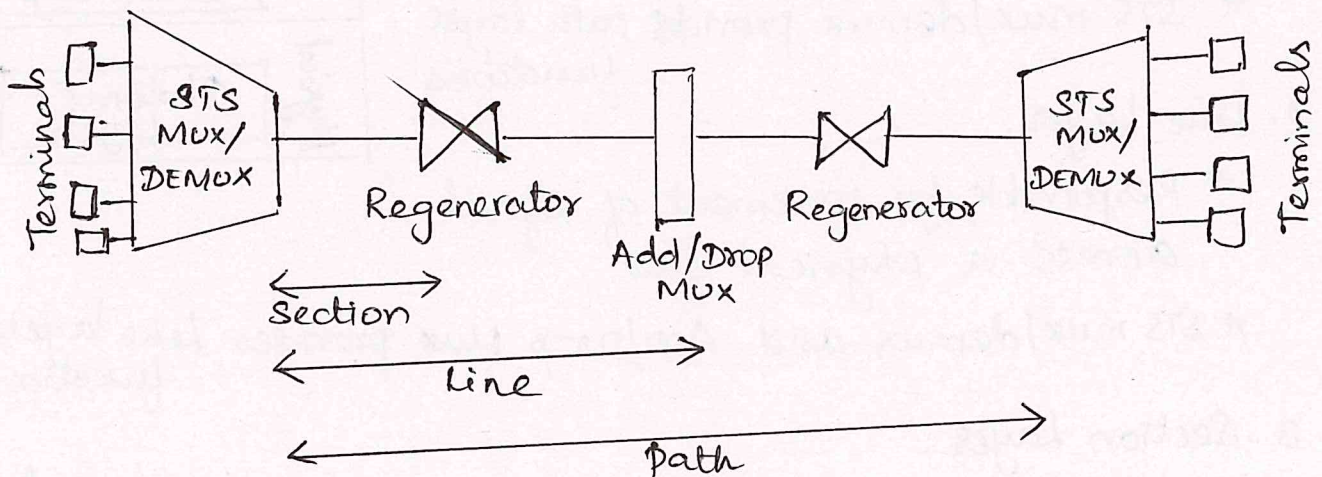



STS Multiplexer: \* Performs multiplexing of signals  
\* Converts electrical to optical signal

STS Demultiplexer: \* Performs demultiplexing of signals  
\* Converts optical to electrical signal.

Regenerator: \* Repeater that takes an optical signal and regenerates (increases strength) it.

Add/drop Mux: \* Allows adding signals from different sources into given path or removing a signal.

SONET is used to convert electrical signal into optical signal so it can travel long distances.

SONET Connections:

- Section: Portion of network connecting two neighbouring devices.
- Line: Portion of network connecting two neighbouring multiplexers.
- Path: End to end portion of network.

SONET Layers:

1. Path Layer:

- \* Responsible for movement of signal from its optical source to destination.
- \* STS mux/demux provides path layer functions.

2. Line Layer:

- \* Responsible for movement of signal across a physical line.

- \* STS mux/demux and Add/Drop Mux provides line layer functions.

3. Section Layer:

- \* Responsible for movement of signal across physical section.
- \* Each device or network provides section layer functions.

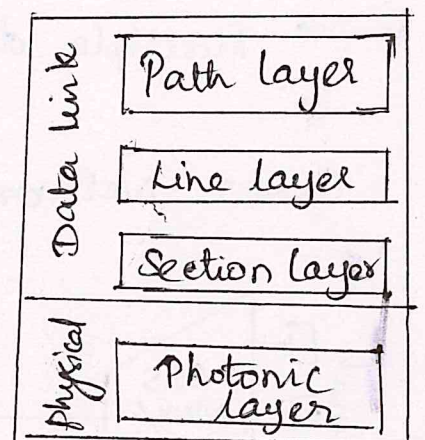



#### 4. Photonic Layer:

- \* It corresponds to physical layer of OSI model.
- \* It includes physical specifications for optical channel.

#### Advantages of SONET:

- 1) Transmits data to long distances.
- 2) High data rates.
- 3) Low electromagnetic interference.
- 4) Large bandwidth.

→ SONET standard is developed by ANSI defines digital hierarchy with base rate of 51.84 Mbit/s.

→ OC notation refers to Optical Carrier level signal.

Base rate signal is OC-1

→ STS level refers to Synchronous Transport Signal from which optical carrier signal is obtained after scrambling and electrical to optical conversion.

#### Levels of SONET signal hierarchy.

<u>Level</u>	<u>Line rate (Mbit/s)</u>
OC-1 (STS-1)	51.84
OC-3 (STS-3)	155.52
OC-9 (STS-9)	466.56
OC-12 (STS-12)	622.08
OC-24 (STS-18)	1244.16
OC-36 (STS-36)	1866.24
OC-48 (STS-48)	2488.32
OC-196 (STS-192)	9953.28
OC-768 (STS-768)	39813.12

STS-1 frame structure enables digital voice signal transport at 64 kb/s and North American DS1-24 channel (1.544 Mbit/s) or European 20-channel (2.048 Mbit/s)



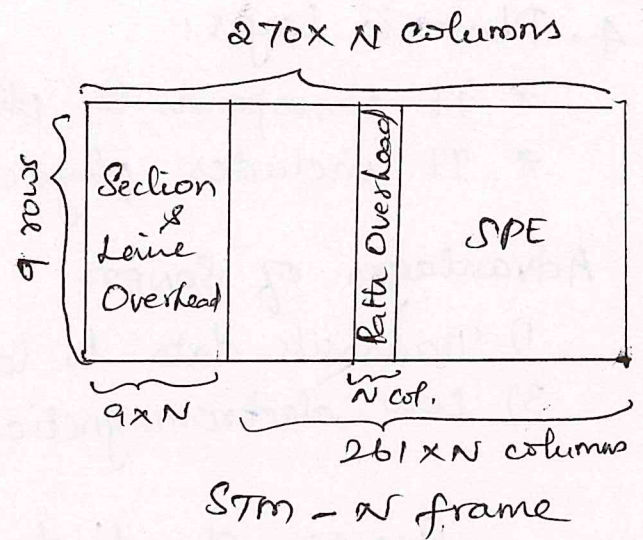
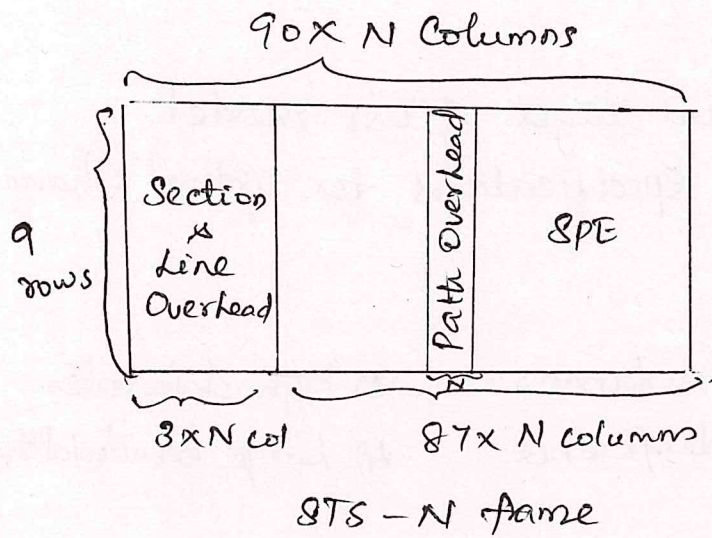

STS-1 frame comprises 9 rows, each 90 bytes, so total 810 bytes or 6480 bits per 125 $\mu$ s frame. This results in 51.84 Mb/s base rate.

The first 3 columns contain transport overhead bytes that carry network management information & 87 columns as sync-payload envelope (SPE).

Apart from first column (9 bytes) used for path overhead, remaining 774 bytes in SPE constitute SONET data payload.

Transport overhead bytes for framing, scrambling, error monitoring, synchronization and multiplexing.

Path overhead with SPE is used to provide end to end communication between systems carrying digital voice, video and other signals which are to be multiplexed into STS-1 signal.

SDH (Sync. Digital Hierarchy) defined by ITU-T; 125 $\mu$ s frame structure is referred as Sync Transport Module (STM) & base rate is 155.52 Mbit/s corresponds to



<u>SDH Level</u>	<u>SONET level</u>	<u>Line rate (mb/s)</u>	<u>SPE rate (Mb/s)</u>	<u>Transport overhead rate (mb/s)</u>
STM-1	OC-3	155.52	150.3366	5.184
STM-4	OC-12	622.08	601.344	20.736
STM-16	OC-48	2488.32	2405.376	84.672
STM-64	OC-196	9953.28	9621.504	331.776
STM-256	OC-768	39813.12	38486.016	1327.104

### Optical Interfaces:

To ensure interconnection compatibility between equipment from different manufacturers, SONET & SDH specifications provide details in the Table.  
(x → STM-x level)

<u>Transmission distance</u>	<u>Fiber type</u>	<u>SONET terminology</u>	<u>SDH terminology</u>
≤ 2 km	G.652	Short Reach (SR)	Intraoffice (I-1)
15 km at 1310 nm	G.653	Intermediate-reach (IR-1)	Short-haul (S-x.1)
15 km at 1550 nm	G.653	" (IR-2)	" (S-x.2)
40 km at 1310 nm	G.655	Long-reach (LR-1)	Long-haul (L-x.3)
80 km at 1550 nm	G.655	" (LR-2)	Very long (V-x.3)

The optical fibers specified in ANSI & ITU falls in 3 categories.

- 1) Graded index multimode in 1310 nm window (O-band)
- 2) Conventional non-dispersion-shifted single-mode in the 1310 nm & 1550 nm windows (O-band & C-band)
- 3) Dispersion-shifted single mode in 1550 nm window (C-band)







Normal traffic travels clockwise in the ring, on primary path in UPSR. The counter clockwise path is used as an alternate route for protection against link or node failures.

In fig. 2, the receiver selects the signal from primary path. It continuously compares the fidelity of each signal and chooses alternate path in case of loss of primary signal.

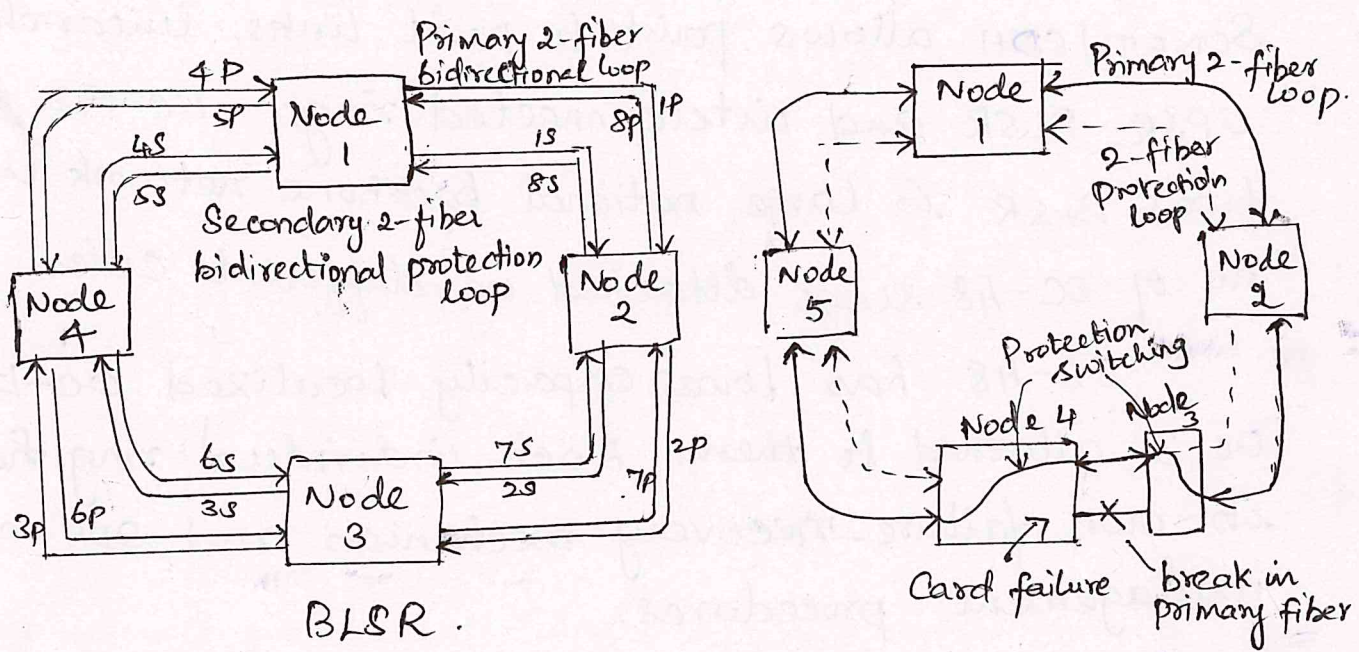

In BLSR, two primary fiber loops (1p to 8p) are used for normal bidirectional communication & other two secondary fiber loops are standby links for protection purposes. (1s to 8s).

Consider connection between nodes 1 & 3 - traffic flows in clockwise then 1p & 2p. In return path, traffic flows in counter clockwise from node 3 to node 1 along 7p & 8p.



## SONET/SDH Networks:

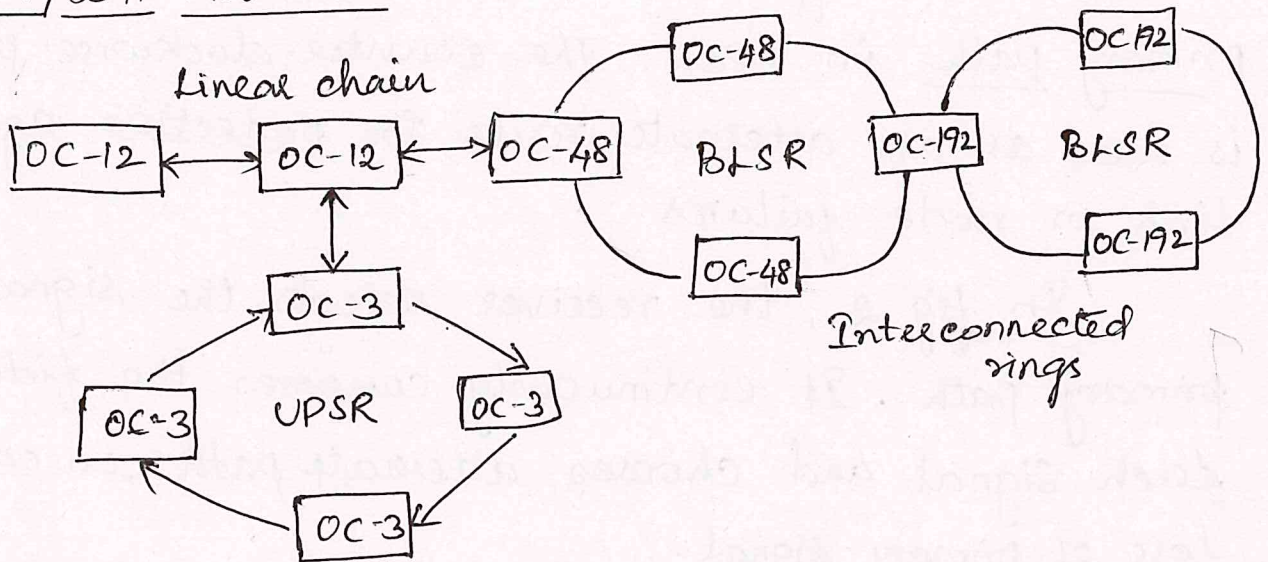

SONET/SDH allows point to point links, linear chains, UPSR, BLSR and interconnected rings. OC-192 four-fiber BLSR is large national backbone network with no. of OC-48 rings attached in different cities.

OC-48 has lower capacity localized OC-12 (or) OC-3 attached to them. Each individual ring has its own failure-recovery mechanism and SDH n/w management procedures.

Fundamental SONET network element is add/drop mux (ADM). It is fully synchronous, byte-oriented that is used to add/drop subchannels within OC-N signal.

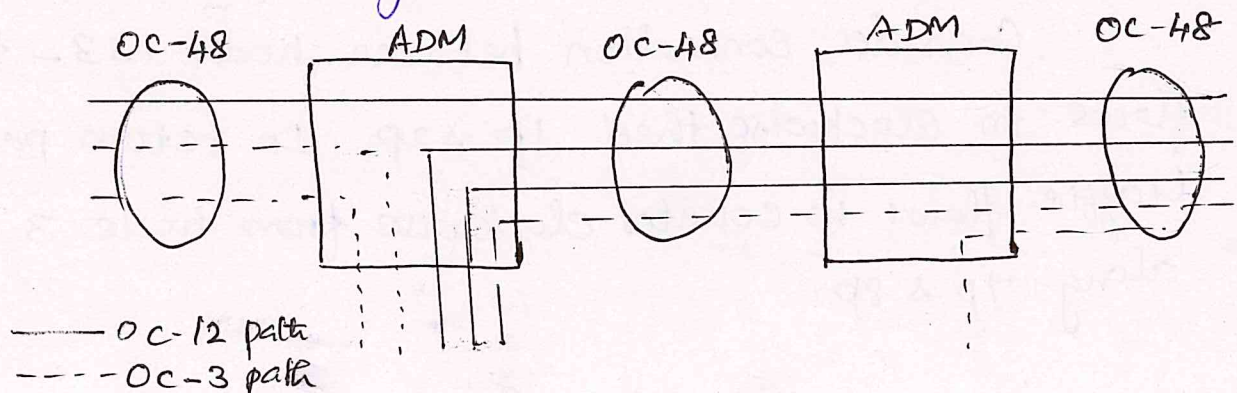



In fig. one OC-12 and two OC-3 channels enter leftmost ADM as part of an OC-48 channel. OC-12 is passed through and two OC-3s are dropped by ADM. Then, two more OC-12s and one OC-3 are multiplexed together with OC-12 channel that is passing through and OC-48 is sent to another ADM node downstream.

SONET/SDH architectures can be implemented with multiple wavelengths. In fig. dense WDM deployment on OC-192 trunk ring for  $n$  wavelengths. o/p of transmitter pass thro' attenuator, then fed into wavelength mux, amplified by post-transmitter optical amplifier & sent thro' fiber.

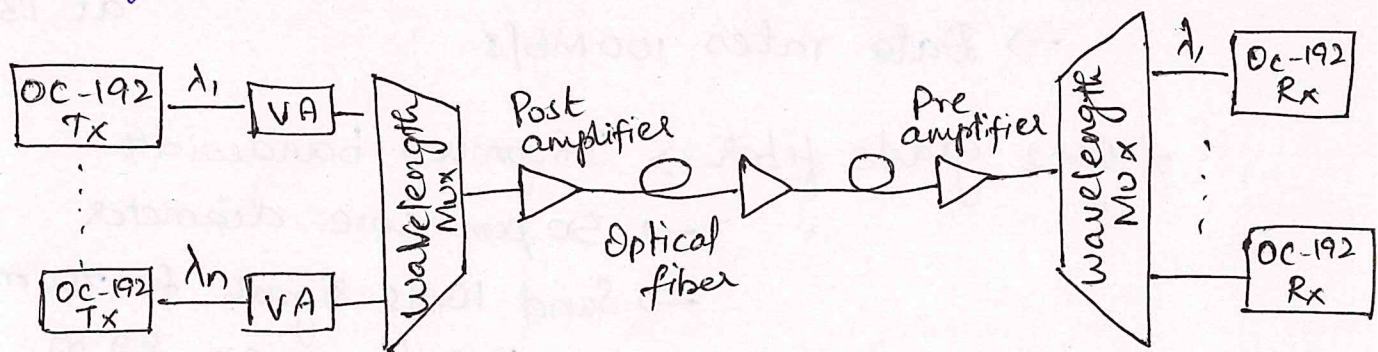

DWDM deployment of  $n$  wavelengths in OC-192 trunk ring.

### High Speed Light wave links:

\* High speed light wave guide is designed for high bandwidth, low power dissipation and for long distance power transmission.

\* The signal is transmitted with high data rate with BER  $< 10^{-15}$ .

### Performance parameters:

- 1) Propagation loss  $< 0.04$  db/cm @ 850 nm
- 2) Data rate = 20 Gps /channel
- 3) Cross talk  $< -20$  db @ 62.5  $\mu$ m pitch.



Ex: Small form factor pluggable (SFP) transceiver used for DWDM applications. Transceivers operate at 2.5 Gb/s for DWDM applications with 100 GHz wavelength spacing.

Links operating at 10 Gb/s:

10 Gb/s Optical fiber systems for storage area nw.

10 Gb Ethernet lines for local-area & metro nw.

ISO Std has 4 types of multimode fiber in terms of bandwidth. They are grades OM1 to OM4.

\* OM1 grade fiber → Original multimode fiber used with LEDs.

→ 62.5  $\mu\text{m}$  diameter core

→ Bandwidth 200 MHz-km at 850 nm & 500 MHz-km at 1310 nm.

→ Data rates 100 Mb/s.

\* OM2 grade fiber → Improved bandwidth

→ 50  $\mu\text{m}$  core diameter

→ Send 1 Gb/s signals for 750 m. distance  
10 Gb/s over 82 m.

\* OM3 grade fiber → high bandwidth

→ Support 10 Gb/s data rate over 300 m distance

\* OM4 grade fiber → Bandwidth 4700 MHz-km for 530 nm

If all geometric parameters of interconnected OM2 and OM3 fibers are the same, then effective

max. length  $L_{\text{max}} = L_{\text{OM2}} \cdot \text{BW}_{\text{OM3}} / \text{BW}_{\text{OM2}} + L_{\text{OM3}}$

where  $L_{\text{OMx}}$  &  $\text{BW}_{\text{OMx}}$  - length & bandwidth only.

OMx grade fiber.



Links operating at 40 Gb/s:

New challenges in terms of transceiver response characteristics, chromatic dispersion and polarization mode dispersion compensation arise when transitioning to high capacity links - 40 Gb/s.

ex: Conventional on-off keying (OOK) modulation format a link operates at 40 Gb/s is 16 times more sensitive to chromatic dispersion, 4 times more sensitive to polarisation mode dispersion & needs Optical SNR is at least 6db high to reach BER. (OSNR)

Other schemes are differential binary phase shift keying (DBPSK). In this, balanced receiver OSNR needed to reach specific BER is 3db lower than OOK. Low OSNR is needed for DPSK to extend transmission distance.

OTDM Links operating at 160 Gb/s:

ex: bit interleaved OTDM.

- Bit-interleaved TDM is similar to WDM in that access nodes share many channels operates at peak rate.
- A laser source produces a regular stream of narrow Return to zero optical pulses at repetition rate  $B$ .
- Range of repetition rate 2.5 to 10 Gb/s.
- Optical splitter divides pulse train into  $N$  Separate streams.
- Each stream is modulated by data source. Modulated ops are delayed & interleaved by an combiner to produce aggregate bit rate.



- Optical post amplifiers & preamplifiers are included to compensate for splitting & attenuation loss.
- At receiver, pulse stream is demultiplexed into original  $N$  independent channels.
- A clock-recovery mechanism operates at base bit-rate  $B$  is required at receiver to drive & synchronize demux.

### OADM Configuration:

- Device that allows the insertion or extraction of one or more wavelengths from a fiber at a network node.

OADM resides at optical amplifier in long haul network and at node in metro network.

→ Fixed optical ADM is OADM

→ Dynamic device is Reconfigurable OADM (ROADM)

Most OADMs constructed using WDM elements using dielectric thin film filters, Arrayed Waveguide Grating, Set of liquid crystal devices / fiber Bragg gratings, with optical circulators.

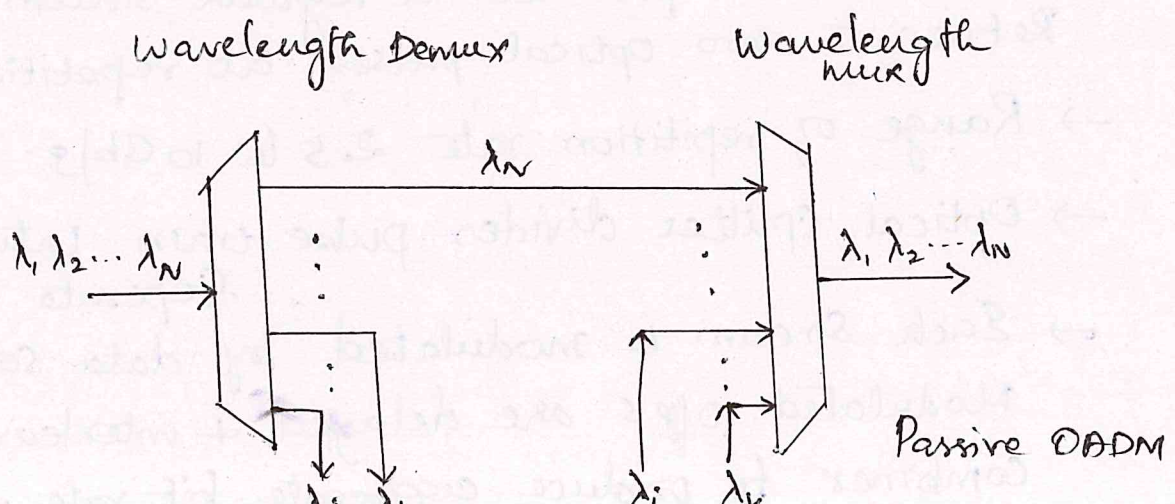



In fig. all incoming wavelengths are separated into individual channels at OADM input by Demux. Any wavelength can be dropped, processed at node, and reinserted on to the outgoing fiber by wavelength mux.  $M$  wavelengths are dropped & remaining  $N-M$  channels pass thro' OADM. The  $M$  dropped wavelengths are  $\lambda_i$  to  $\lambda_k$ .

### Reconfigurable OADM :

- reconfigured by network operator. To drop and add selected wavelengths on particular node is Service provisioning on the fly.

- ROADMs include wavelength blockers, arrays of small switches, and wavelength selective switches.

### ROADM features :

\* Wavelength dependence :

When ROADM is dependent of wavelength  $\rightarrow$  Colored ports

When ROADM is independent of wavelength  $\rightarrow$  Colorless ports.

\* ROADM degree : No. of bidirectional multi wavelength interfaces the device supports.

\* Express channels : allow a selected set of wavelengths to pass thro' the node without the need for Optical-to-Electrical-to-Optical Conversion.



\* Modular expansion - To avoid initial high setup cost to connect transmitters & receivers to add/drop port service providers, first activate min. no. of ports needed to support current traffic & add more channels as service demand increases. This is pay as you grow approach

\* Minimum Optical impairment :- To avoid accumulation of impairments like crosstalk, wavelength dependent attenuation, polarization dependent loss.

Wavelength blocker configuration:

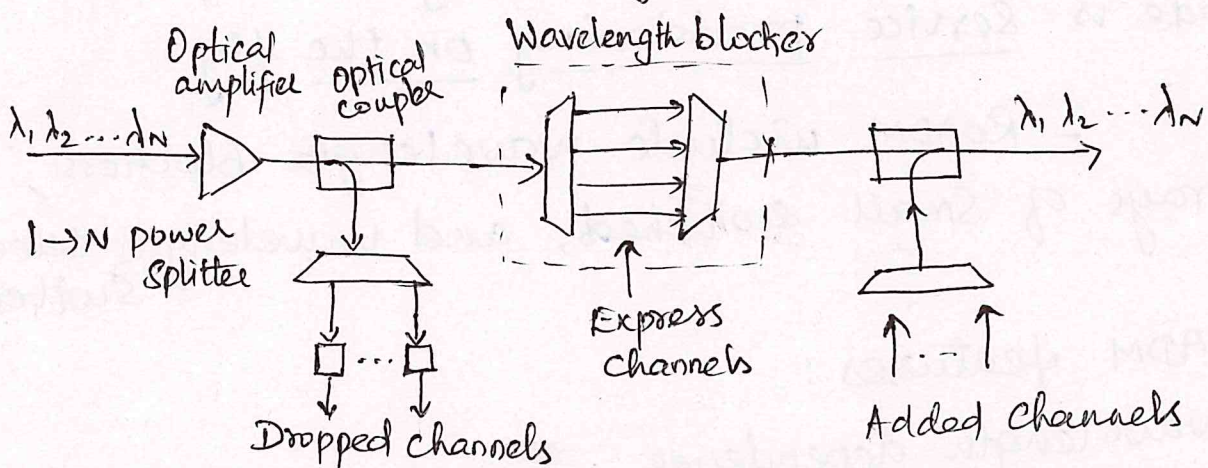

In this, passive optical coupler splits the incoming light wave signal power into 2 paths. One in express path & another in drop site.

Wavelength blocker in express path block those wavelengths received at node.

Drop segment contains  $1 \times N$  optical power splitter, which divides light signal into  $N$  tunable filters that allow selection of any desired wavelength.



The add segment contains  $N$  tunable laser sources that allow inserted wavelength to join express wavelength by power combiner and passive optical coupler.

Drawback: Large size.

### Switch Array Configuration:

In colored switched array, (demux-switch-mux approach.)  $N$  incoming wavelengths pass thro' demux. Individual  $2 \times 2$  switches allow wavelength to bypass or drop it.

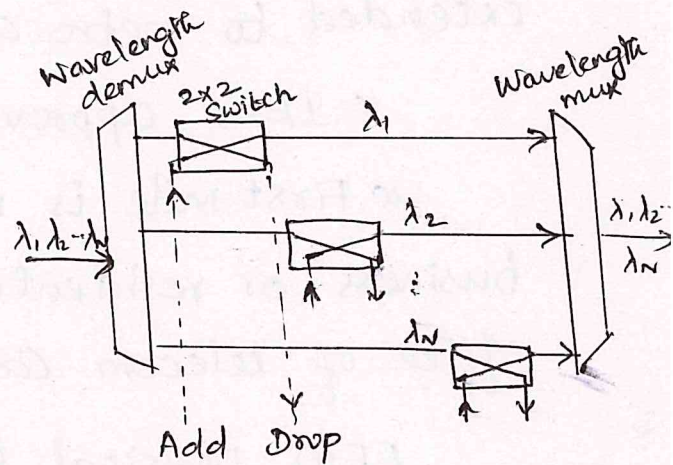

### Wavelength - Selective Switch Configuration:

A basic ROADM is formed by WSS module for dropping and adding them. Each module contains set of wavelength selective switches.

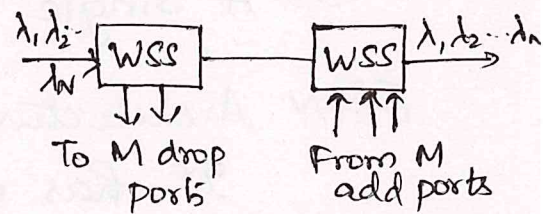

If  $N$  incoming wavelengths that are switched to any of output ports, then WSS module contains  $N$  wavelength selective switches of size  $1 \times M$ .



## Optical ETHERNET:

It is designed to send 10/100 Mb/s, 1Gb/s & 10Gb/s Ethernet frames directly over optical fibers. Optical Ethernet offers reduced network complexity.

It is mostly used in local area + Campus n/w & extended to metro and wide area n/w.

\* IEEE approved 802.3 Ethernet in First Mile (EFM) Std

\* First mile is n/w infrastructure that connects business or residential subscribers to the central office of telecom carrier or service provider.

EFM physical support schemes are:

1. Individual Point to Point (P2P) links.
2. A single P2P link to multiple users.
3. A single bidirectional ethernet passive optical n/w (EPON)

## EPON Architecture:

It has one main feeder line going to an optical splitter. Up to 32 distribution branches leave the splitter and interface to ONTs. IEEE Std specifies operational conditions for a distance of 10 to 20 km between OLT and ONT. Distance depends on splitter size.

EPON uses media access control (MAC) and physical layer (PHY) chipsets. It uses 1490 nm wavelength for downstream transmission of voice and data to ONTs and 1310 nm for upstream return path from ONT to OLT. EPON has nominal bit rate 1250 Mb/s.



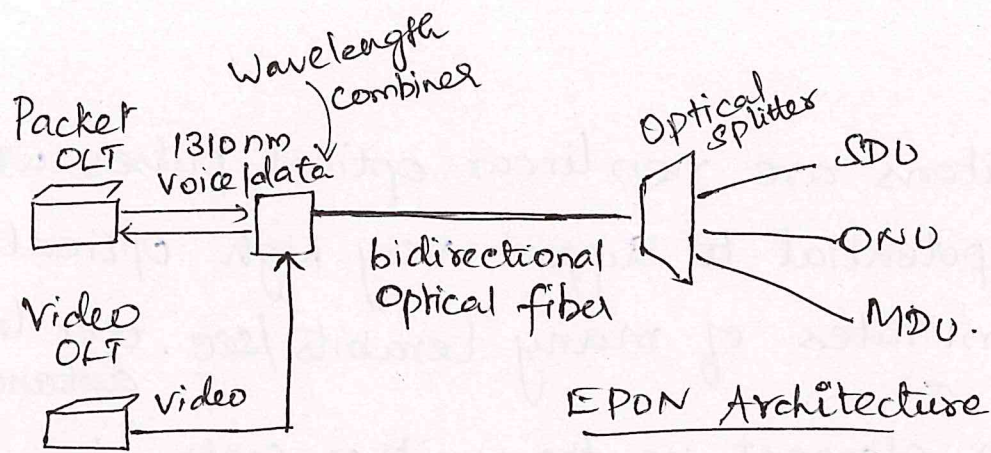

### Metro Optical Ethernet:

- Based on advanced switching methodology.
- Allows ethernet over greater distance.
- Allows business customers to connect multiple locations within a service area.
- Transmission speed range from 3 Mb/s to 1 Gb/s.

In fig. the interface to metro backbone is 10 Gb/s Ethernet Switch, used to exchange traffic from entities like local telecom

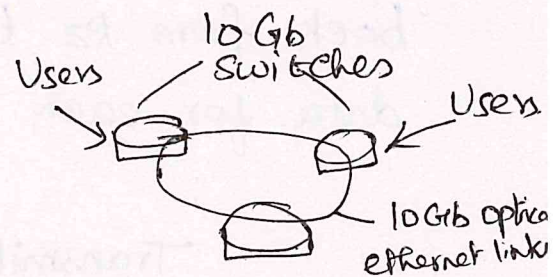

equipment, remote users, branch offices + business partners. This is known as metropolitan aggregation.

Metro ethernet switches have variety of interface capabilities ranging from 10 Mb/s to 1 Gb/s. Switches offer high degree of flexibility. They integrate service provisioning, network management etc.



## Solitons:

\* Solitons are non linear optical pulses which have the potential to support very high optical transmission rates of many terabits/sec. over long distances.

Major element in transmitter section is RZ pulse generator. To generate Return to Zero (RZ) pulses is to employ an optical modulator and an NRZ to RZ converter driven by DFB laser source.

Here, Mach Zender modulator is used to modulate NRZ data at desired transmission rate.

At Receiver, incoming signal requires conversion back from RZ to NRZ and demux. Separates NRZ data for each channel.

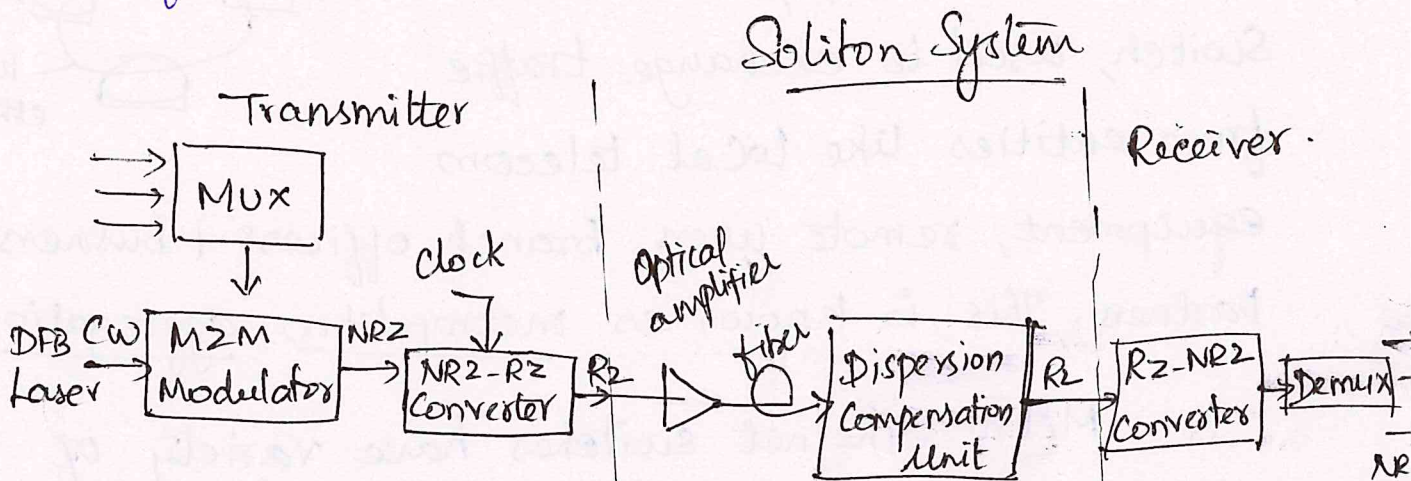

The generation of optical soliton pulses is to achieve soliton transmission where transmitter is required to produce RZ pulses. RZ pulse source is realized using an RZ laser source such as mode-locked fiber ring laser. A cw laser



Source generates an optical signal passed thro' the phase modulator driven by encoded NRZ data signal.

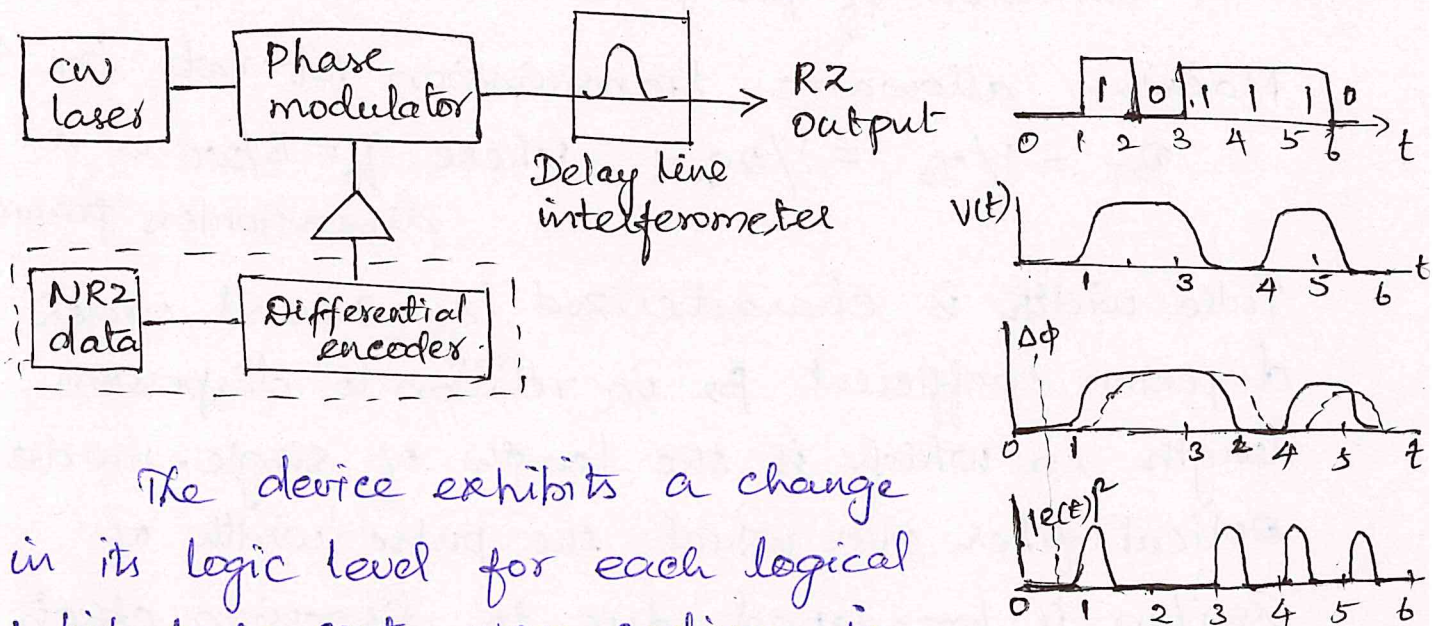

The device exhibits a change in its logic level for each logical 1 bit to be sent, NRZ coding is achieved in digital domain which is accomplished using digital logical gate.

The optical delay line interferometer is adjusted for constructive interference where it converts NRZ phase modulation into RZ pulses with a width corresponding to optical delay.

Optical soliton transmission systems can be single-wavelength or multiwavelength channel.

Single-wavelength channel system - only one transmitter is used to launch RZ pulses on the optical fiber.

Multi-wavelength-channel optical soliton systems, employ several transmitters where data is multiplexed using WDM, it is difficult to realize such a source to operate at the ultra-high frequencies needed to maintain necessary narrow pulse widths.



Transmission bit rate depends on two factors:

- \* Soliton pulse width  $\tau$
- \* duration of bit period  $T_0$ .

Maximum allowable transmission bit rate  $B_T$  as

$$B_T = 1/T_0 = 1/2q_0\tau \quad \text{where } q_0 = T_0/2\tau \text{ is a dimensionless parameter.}$$

Pulse width is characterized by second order dispersion coefficient  $\beta_2$  in relation to dispersion length  $L_D$  which is the length of single-mode optical fiber over which the pulse width of soliton is broadened due to dispersion effects.

$$L_D = \tau^2 / |\beta_2|$$

Transmission rate for soliton propagation when the amplifier spacing is smaller than dispersion length.

$$B_T \ll 1/2q_0 (|\beta_2| L_A)^{1/2} \quad (\text{i.e. } L_A \ll L_D)$$

For  $L_A \gg L_D$ ,  $B_T \gg 1/2q_0 (\alpha / |\beta_2|)^{1/2}$

$$\text{where } \alpha L_D \ll \alpha \tau^2 / |\beta_2| \ll 1.$$

Ex: An optical fiber soliton transmission system has an amplifier spacing of 50 km that is smaller than fiber dispersion length. RZ pulse width is 6 ps with bit period of 70 ps. If second order dispersion coefficient is  $-0.5 \text{ ps}^2 \text{ km}^{-1}$ . Find a) Separation for the soliton pulses to avoid interaction.  
b) Transmission bit rate of optical soliton communication system.



a) Separation of soliton pulses  $q_0 = \frac{T_0}{2\tau} = \frac{70 \times 10^{-12}}{2 \times 6 \times 10^{-12}} = 5.8$

b) Transmission bit rate  $B_t \ll \frac{1}{2} q_0 (1/\beta_2 |kA|)^{1/2}$   
 $B_t \ll \frac{1}{2} \times 5.8 (-50 \times 10^{-12} \times 10^{-12} \times 10^{-3} \times 50 \times 10^3)^{1/2}$   
 $\ll 17.24 \times 10^9$ .

Hence, max. bit rate will be much less than 17.2 Gb/s for soliton transmission with optical amplifiers placed at an interval of 50 km.

In practice, a suitable transmission rate would be around 10 Gb/s.

2. A transmitter has an output power 0.1 mW. It is used with fiber having NA = 0.25, attenuation 6 db/km length 0.5 km. The link contains two connectors of 2 db average loss. The receiver has minimum acceptable power (sensitivity) of -35 dbm. The designer has allowed a 4 db margin. Calculate link power budget? (Dec-19.)

Source Power  $P_s = 0.1 \text{ mW} = -10 \text{ dBm}$ . NA = 0.25

∴ Coupling loss =  $-10 \log(\text{NA}^2) = -10 \log(0.25^2) = 12 \text{ db}$ .

Fiber loss =  $\alpha_f \times L = 6 \text{ db/km} \times 0.5 \text{ km} = 3 \text{ db}$

Connector loss =  $2(2 \text{ db}) = 4 \text{ db}$ .

Design margin  $P_m = 4 \text{ db}$

∴ Actual O/p power  $P_{out} = \text{Source power} - (\sum \text{losses})$   
 $= 10 \text{ dbm} - (12 \text{ db} + 3 + 4 + 4)$

$P_{out} = -33 \text{ dbm}$ .



Since, receiver sensitivity  $P_{min} = -35 \text{ dbm}$ .

As  $P_{out} > P_{min}$ , system will perform adequately over the system operating life.

3. For a multimode fiber link following parameters.

i) LED with drive circuit has rise time  $15 \text{ ns}$ .

ii) LED spectral width =  $40 \text{ nm}$ .

iii) Material dispersion related rise time degradation =

iv) Receiver bandwidth =  $25 \text{ MHz}$ .  $21 \text{ ns}$  over  $6 \text{ km}$  link.

v) Modal dispersion rise time =  $3.9 \text{ ns}$ . Calculate system rise time.

$$t_{tx} = 15 \text{ ns}, \quad t_{mat} = 21 \text{ nsec}, \quad t_{mod} = 3.9 \text{ nsec}.$$

$$\text{Now, } t_{rx} = \frac{350}{B_{rx}} = \frac{350}{25} = 14 \text{ ns}.$$

$$t_{sys} = \left( \sum_{i=1}^N t_{ri}^2 \right)^{1/2} = [15^2 + 21^2 + 3.9^2 + 14^2]^{1/2}$$

$$t_{sys} = 29.61 \text{ nsec}.$$

4. An optical fiber is designed to operate an  $8 \text{ km}$  length without repeaters. The rise times of components are

Source (LED) :  $8 \text{ ns}$ . Fiber cable: Intermodal :  $5 \text{ ns/km}$

Detector (p-in) :  $6 \text{ ns}$ . Intra-modal :  $1 \text{ ns/km}$ .

Estimate max-bit rate that is achieved on the link when using NRZ & RZ format.

$$\text{Given } t_{tx} = 8 \text{ ns}, \quad t_{intra} = 1 \text{ ns/km}, \quad t_{modal} = 5 \text{ ns/km}$$
$$t_{rx} = 6 \text{ ns}, \quad \text{length } L = 8 \text{ km}$$

$$t_{system} = [t_{tx}^2 + t_{modal}^2 + t_{intra}^2 + t_{rx}^2]^{1/2}$$
$$= [8^2 + (5 \times 8)^2 + (1 \times 8)^2 + 6^2]^{1/2} = 42 \text{ ns}.$$

$$\text{Max. bitrate for NRZ, } B_T = 0.7 / t_{sys} = \frac{0.7}{42 \times 10^{-9}}$$

$$B_T = 16.6 \text{ Mb/sec}.$$

$$\text{Max. bitrate for RZ, } B_T = 0.35 / t_{sys} = \frac{0.35}{42 \times 10^{-9}} = 8.33 \text{ Mb/sec}.$$



# Introduction:

## UNIT V OPTICAL NETWORKS

An optical fiber network commonly referred to as an optical network is a telecommunication network with optical fibers as the primary transmission medium which is designed in such a way that it makes full use of the unique attributes of optical fibers.

\* It may be noted that the synchronous digital hierarchy or synchronous optical network (SONET) based point-to-point approaches of 1980s are in the process of being upgraded with wavelength routed networking technologies.

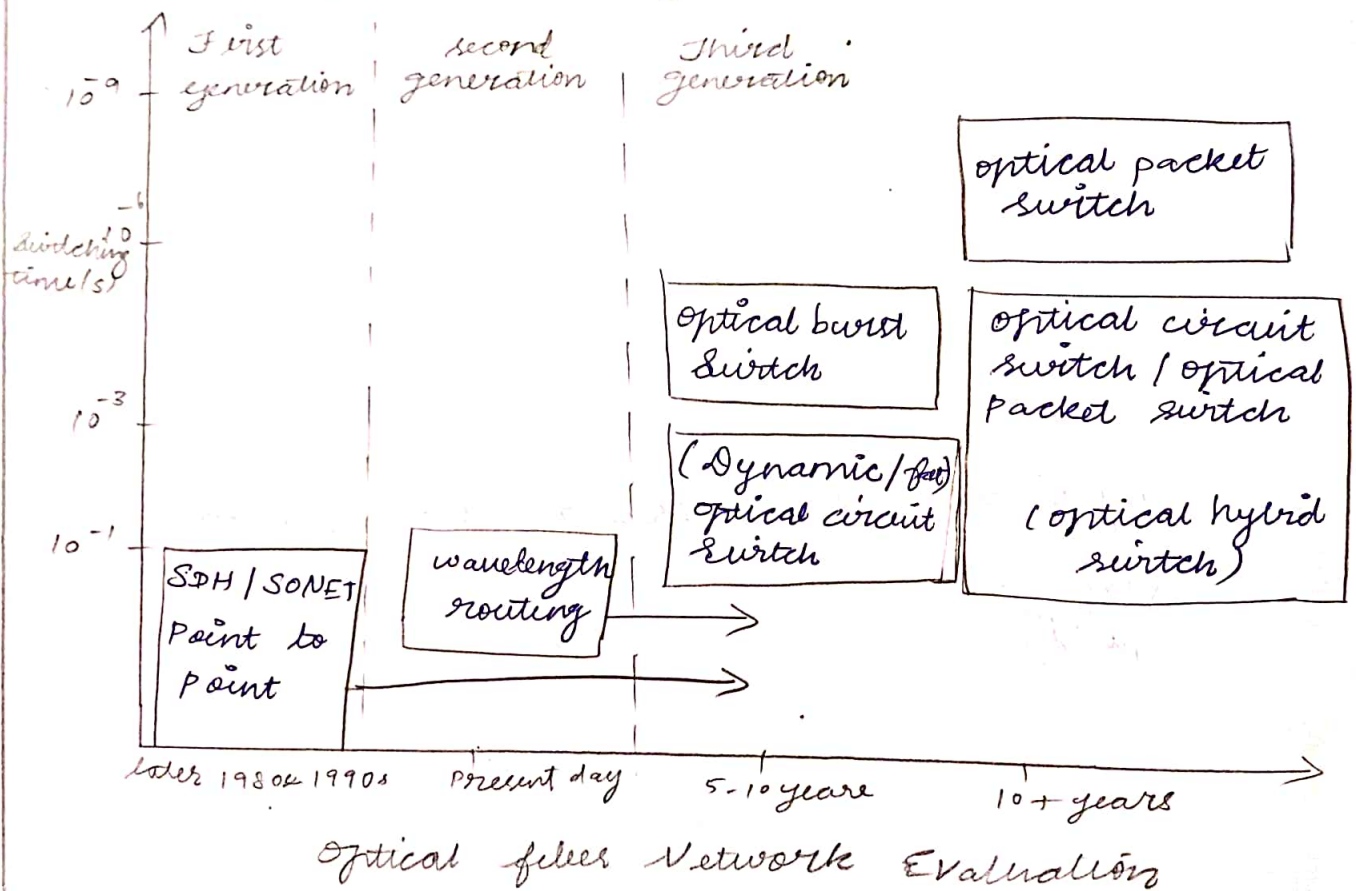



## Optical fiber Concepts:

\* A Network utilizing optical fibers as a transmission medium provides a connection between many users to enable them to communicate with each other by transporting information from a source to a destination.

\* A signal carried on a dedicated wavelength from source to a destination node is known as a lightpath (i.e.  $\lambda_1, \lambda_2$  are two lightpaths in this particular case). The data can be sent over these lightpaths once the connections are set up.

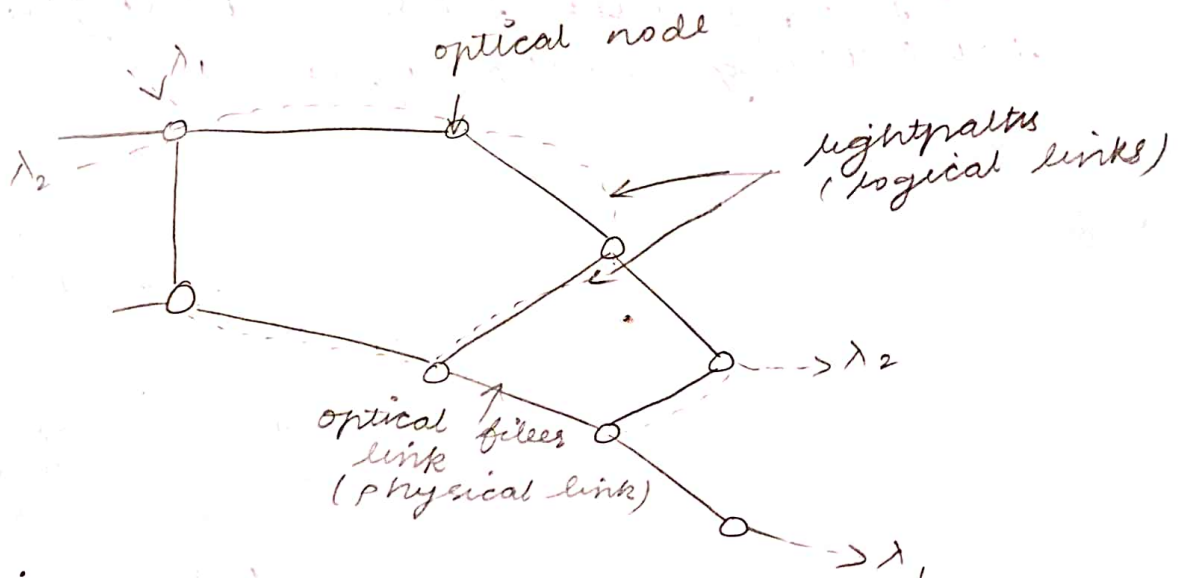

## Optical Networking terminology:

nlw topology

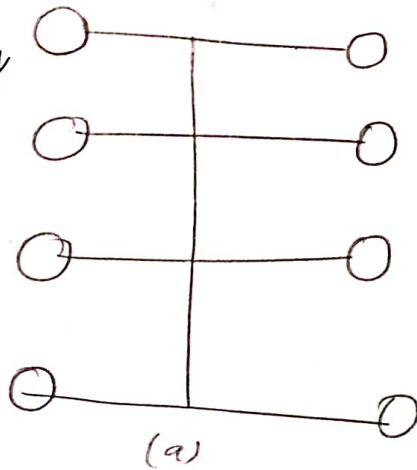

(a)

Bus

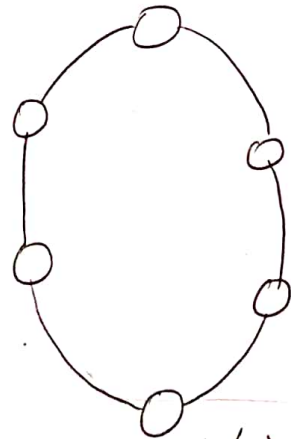

ring (b)



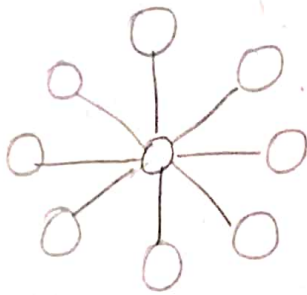

(c)  
Star

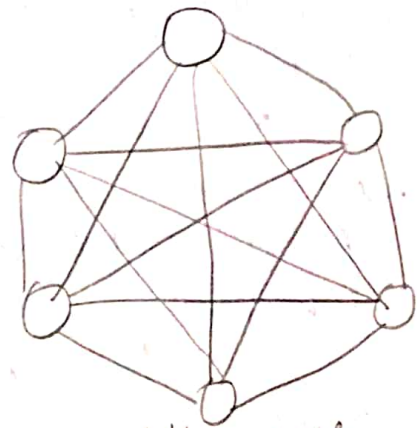

(d) Mesh

### Bus topology:

\* In bus topology, the data generally circulates bidirectionally.

\* Data is input and removed from the optical fiber bus via four-port couplers located at the nodes.

### Ring topology:

\* In the ring configuration, the data usually circulates unidirectionally, being looped through the nodes at each coupling point,  $\Sigma$ , hence it is separately regenerated in phase and amplitude.

### Star Topology:

\* An optical star coupler forms a central hub to the network which may be either active or passive.

\* In passive operation, the star coupler at the hub splits the data in terms of power so that the signal is transmitted to all nodes.

\* Overall losses are therefore



primarily determined by the number of splits.

\* With an active hub the data is split in an optoelectronic star coupler which carries out both O/E and E/O conversion and therefore this process does not contribute to the overall network losses.

### Mesh\* Topology

\* The ring and star topologies are combined in mesh configuration to provide interconnections among the network nodes.

\* It is referred to as full-mesh when each network node is interconnected with all nodes in the network.

### Question: Expectations.

- 1) Explain about optical fibres concepts along with its generations.
- 2) What is optical Networking terminology? Explain the types along with neat sketch.



# Optical Network Node and Switching Elements

\* An optical node is considered as a multifunctional element that performs several tasks depending upon its type and the network requirements.

\* It sends, receives and resends or redirects optical signals to its neighbouring connected nodes.

\* A router essentially comprises optical couplers where desired signal from an incoming multiplexed signal is isolated and then directed or routed to the output port.

\* Four different functions of an optical router,

\* Wavelength demultiplexer

\* Wavelength multiplexer.

\* Optical add / drop multiplexer

\*  $2 \times 2$  optical switch

\* Reconfigurable optical add / drop multiplexer.



# Wavelength Demultiplexer :-

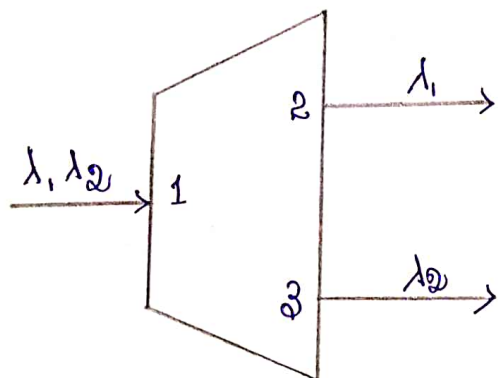

# Wavelength Multiplexer:

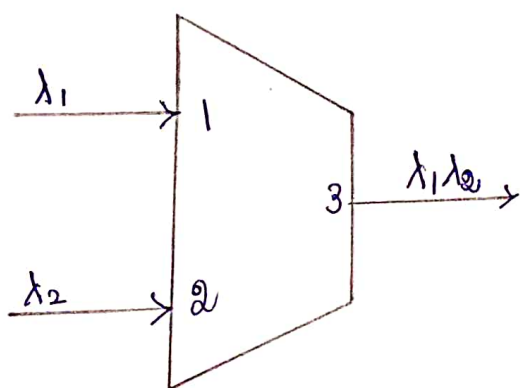

# Optical Add / Drop multiplexer:

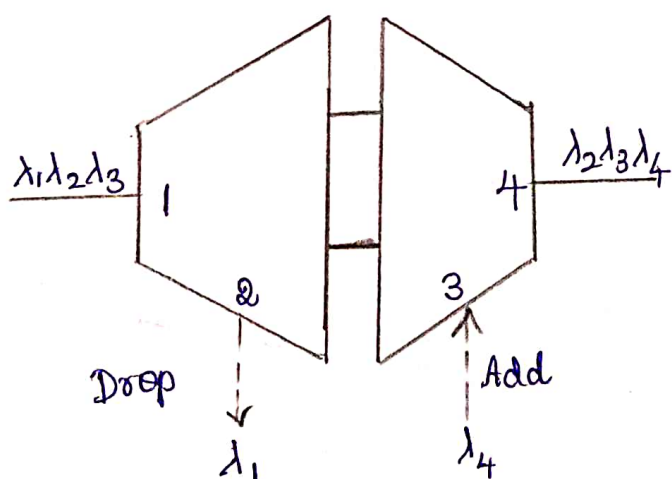



## 2 x 2 Optical Switch :-

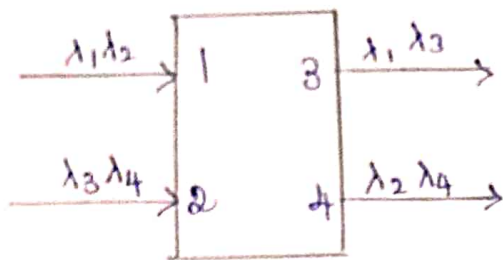

## Reconfigurable Optical Add / Drop Multiplexer:

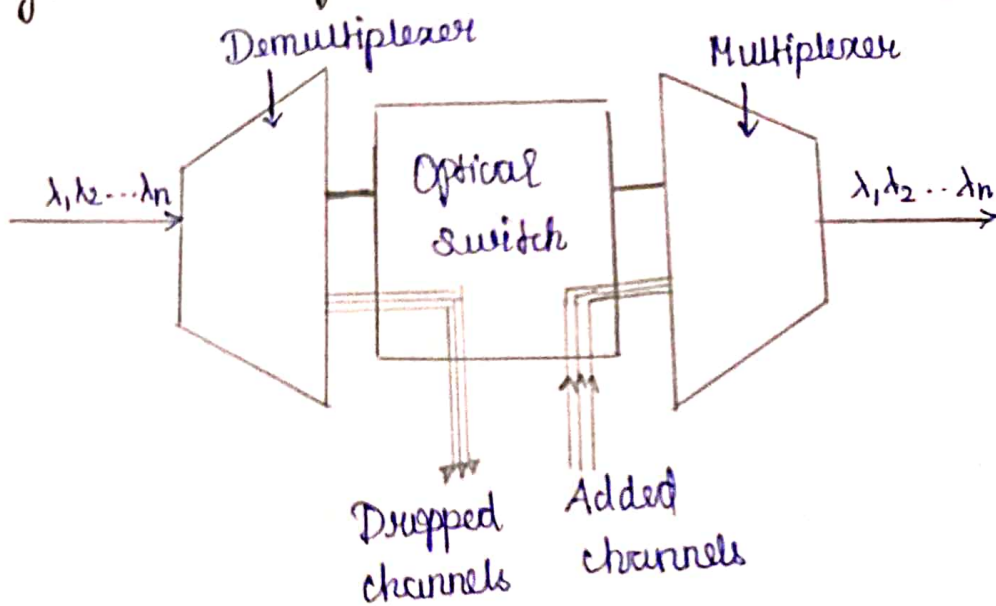

## Optical cross connect :-

### Block Schematic :-

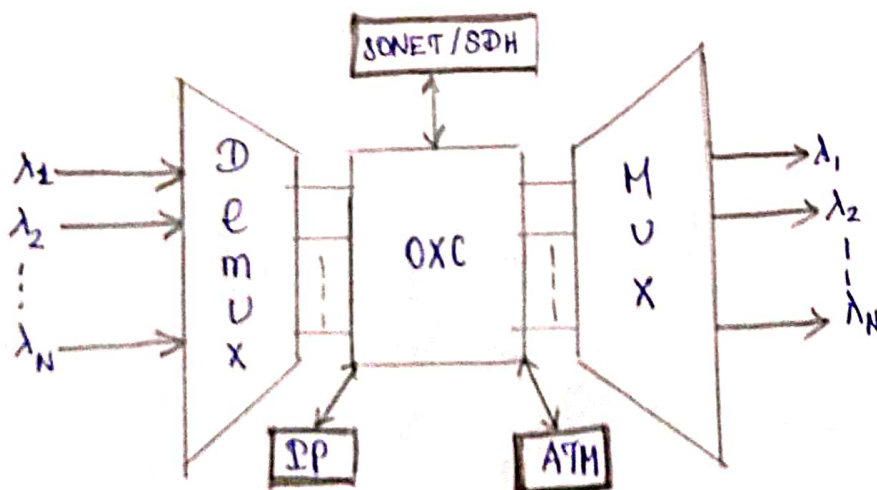



## Fiber cross connections

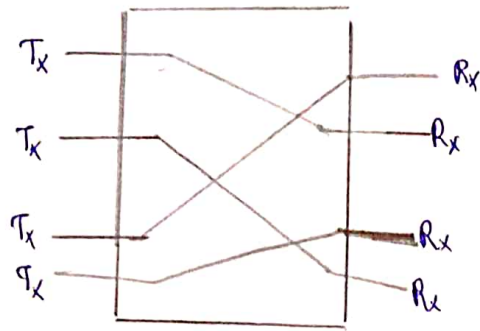

## Logical cross connections

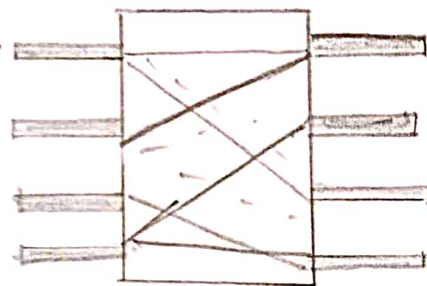

## Broadcast and select network

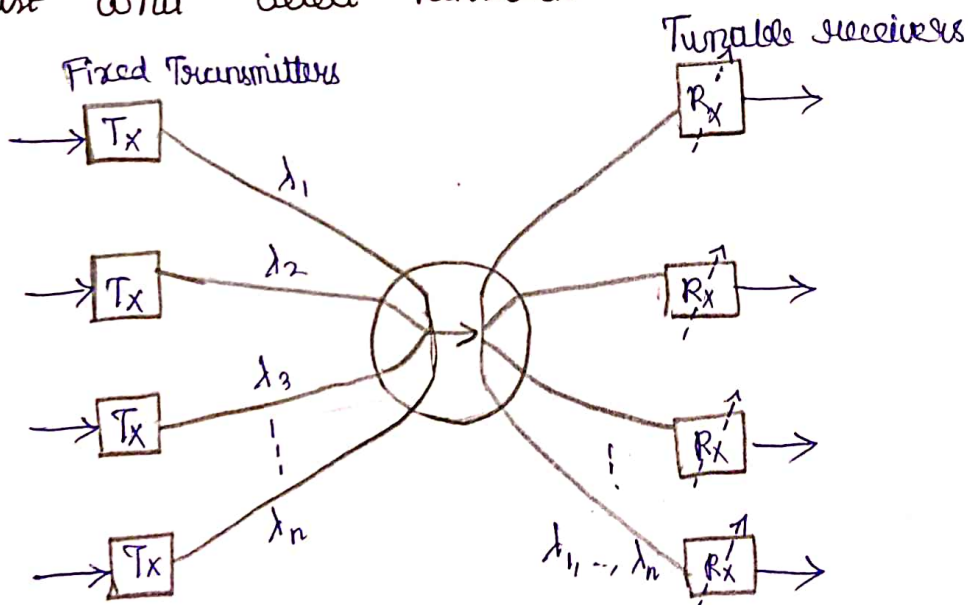

## Wavelength Division Multiplexing :-

\* Wavelength division multiplexing technique is classified as either Broadcast and select network (or) wavelength routing networks.



\* Broadcast and select network strategy is based on star coupler.

\* It should be noted that all transmission are broadcasted to all network nodes and hence most of transmitted power is depleted on the receivers which do not use it.

\* wavelength routing - consisting of five node (A, B, C, D, E) interconnected to each other.

Physical connection:

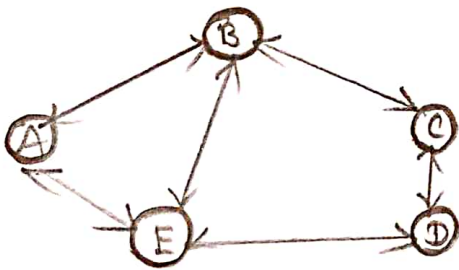

wavelength Assignments:

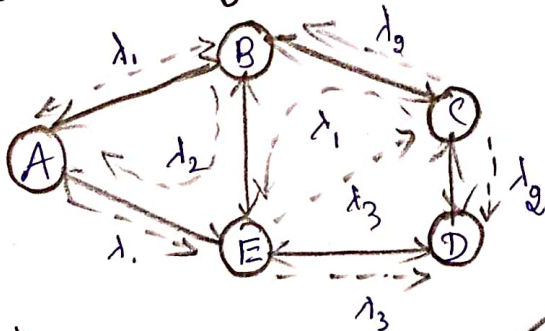

Virtual topology:

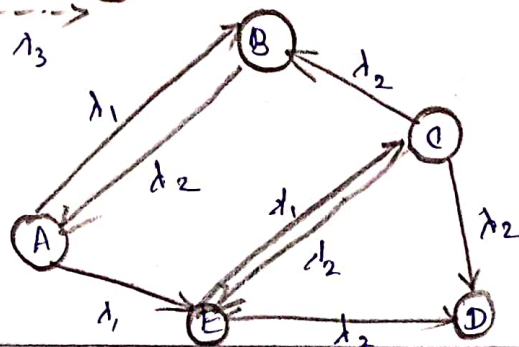



## Public Telecommunication network Overview :-

★ The telecommunication network providing services in the public domain is known as the public telecommunication network where the service providers offer a variety of services for the provision of voice, data & video transmission.

★ A simple block diagram of hierarchy for the optical public telecommunication network is illustrated in fig which is divided into long haul, Metropolitan, Access networks.

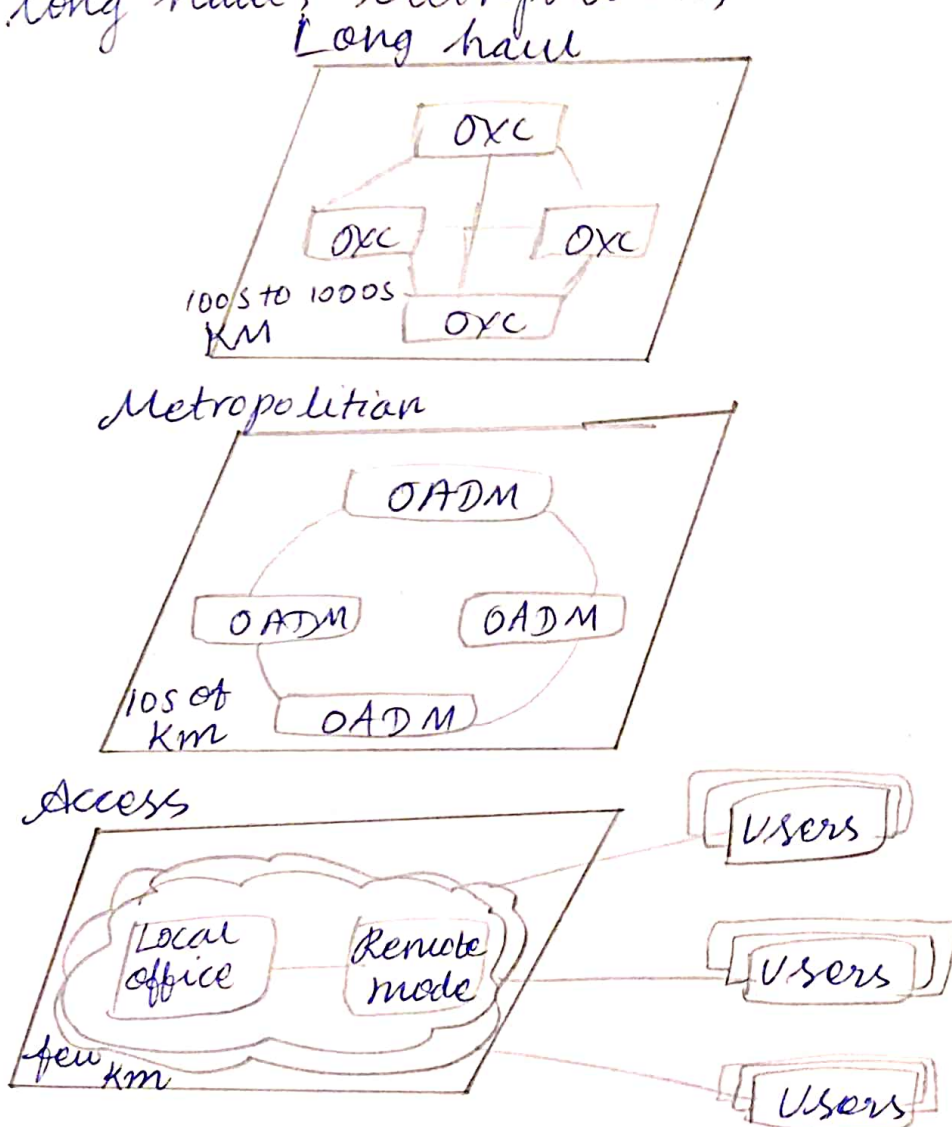

★ The long haul network, also known as the core or sometimes the backbone network, provides national or global coverage with a reach of thousand of kilometers.



\* At the next lower hierarchical level resides the metropolitan area network (MAN) often called the metro or sometimes the back-haul network. These networks offer a multi-service platform and may be confined to a region spreading to tens of kilometers.

\* The lowest tier in the hierarchy is the local access network which may be extended from a few hundreds of meters to 20 km and so. Hence the access network provides the initial interface to the telecommunication network for residential and business customers.

\* The users are connected to a branching node known as a remote node (RN) which interconnects the users with the local office/telephone exchange. In order to provide larger interconnectivity, several local office/exchanges are connected using a metropolitan area network.

Optical network Transmission Modes, layers and protocols.

~~\*~~  
Synchronous network:-

\* A schematic of the way in which the European hierarchy is multiplied up to 140 Mbit/s<sup>-1</sup> rate from the constituent 2 Mbit/s<sup>-1</sup> signals is shown in fig. Difficulties arise, however, adopted throughout the world, in that each 2 Mbit/s<sup>-1</sup> has its own independent clock to provide for timing and synchronization. This results in slightly different frequencies occurring throughout a network and is referred to as PLEISYNCHRONOUS TRANSMISSION.



★ Although this strategy is well suited to the transport of bits it suffers a major drawback in that in order to multiplex the different levels extra bits need to be inserted at each intermediate level so as to maintain plesynchronous operation.

★ The presence of bit stuffing in the transport of bits it suffers a major drawback in that in order to multiplex the different levels to identify and extract an individual channel from within a high-bit-rate transmission link. Thus to obtain an individual channel the whole demultiplexing procedure through the various levels must be carried out. A substantial saving in electronic hardware together with increased reliability could be achieved by having straight say 2 to 140M bit s<sup>-1</sup>, multiplexing/demultiplexing capability as illustrated in fig.

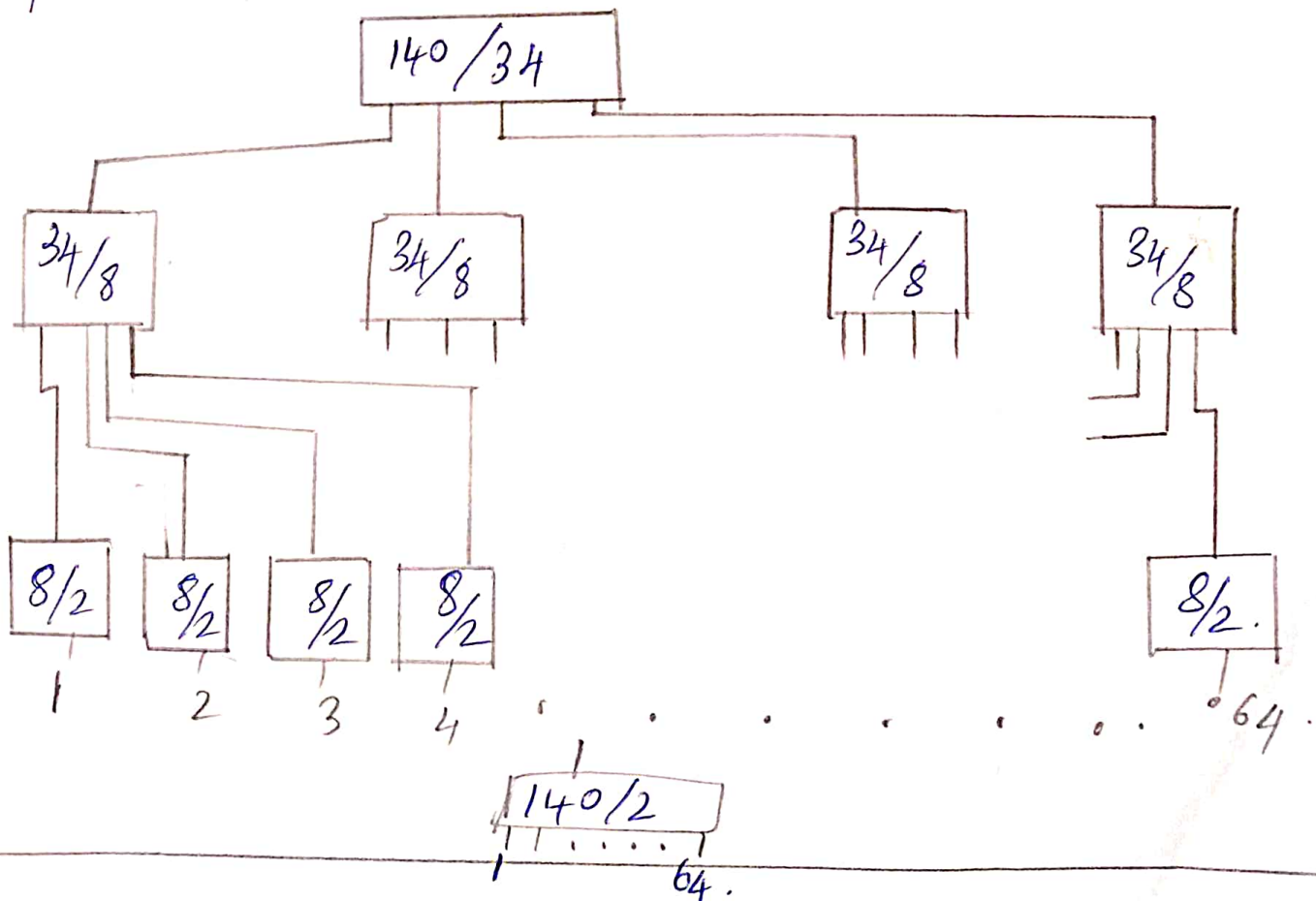



## Synchronous Multiplexing

Level	STS	LINE RATE (4bits <sup>-1</sup> )
OC-1	(STS-1)	51.840
OC-3	(STS-3)	155.520
OC-9	(STS-9)	466.560
OC-12	(STS-12)	622.080
OC-24	(STS-24)	1244.160
OC-36	(STS-36)	1866.240
OC-48	(STS-48)	2488.320
OC-196	(STS-196)	9953.28
OC-768	(STS-768)	39813.12

\* The Basic STS-1 frame structure illustrated in fig comprises 9 Rows each of 90 Bytes which therefore provide a total of 810 bytes or 6480 Bits per 125  $\mu$ s frame. The first 3 Bytes in each row of the STS-1 frame contain transport overhead Bytes, leaving the Remaining 783 bytes to be designated as the synchronous payload envelope (SPE).

\* Apart from the first column which is used for the path overhead, the remaining 774 bytes in the SPE constitute the SONET data payload. The transport overhead bytes are utilized for functions such as framing scrambling, error monitoring.



## Synchronization and Multiplexing:-

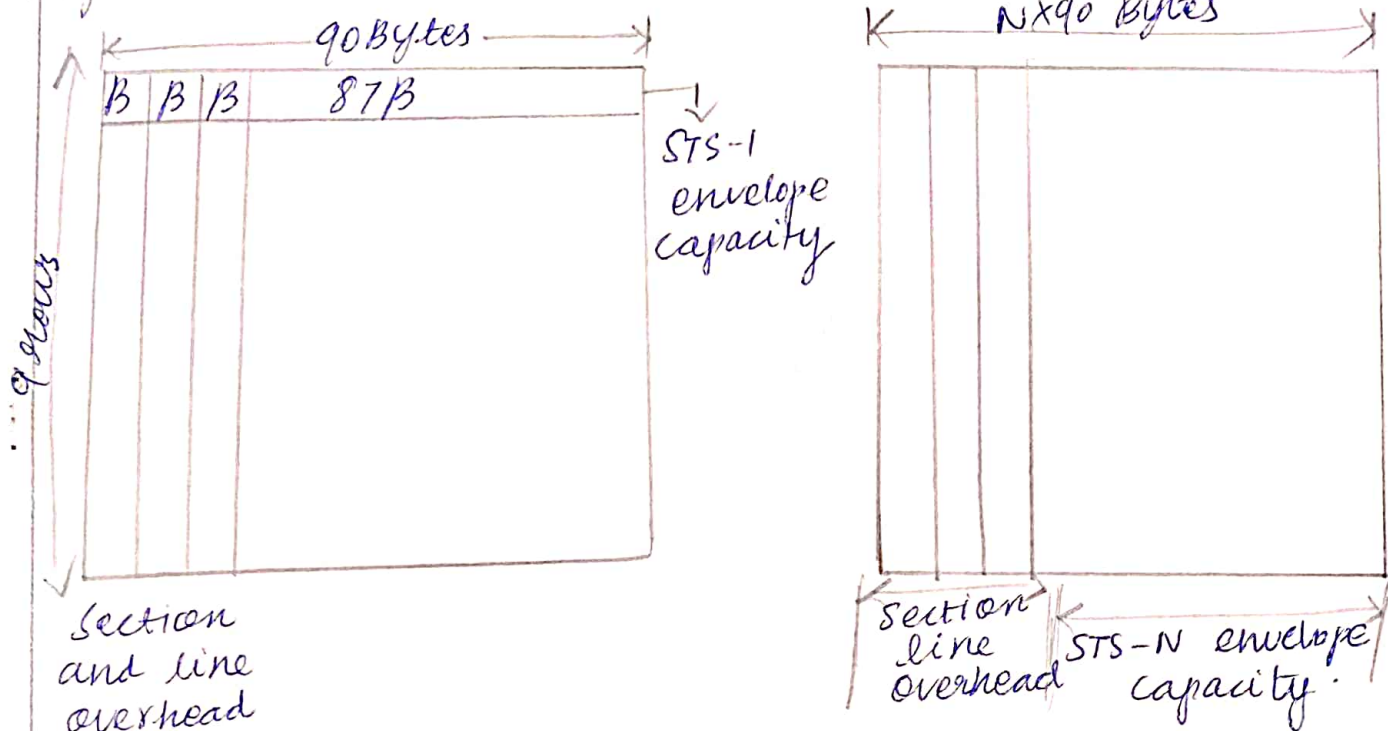

## Asynchronous Transfer Mode (ATM):

★ ATM is a packetised multiplexing and switching technique which seems to combine the benefits of packet switching and circuit switching.

ATM transfers information in fixed-size units called cells where each cell contains the information identifying the source of the transmission but which generally contain less data than packets.

★ ATM is asynchronous and therefore the time slots are made available on demand. So enable correct segmentation and assembly of different cells at the destination, path, channel significant information in addition to data. An ATM cell comprises a header and payload data as shown in figure. It contains 48 bytes of data with 5 bytes of header information.

★ Each single byte in the header field includes different information to identify destination, path, channel and error control



Bits Before sending ATM cells carrying user data a virtual connection between source and destination has to be established. All connections follow the same path within the network. During the connection setup each control bit generates an entry in the virtual path identifier transition table to inform the destination to receive the incoming packets.

Header (5 bytes)	PAYLOAD (48 Bytes)
---------------------	-----------------------

Expected university questions:-

Part - B

- 1) Explain about the overview of public tele communication network overview
- 2) Block diagram of public tele communication network.
- 3) Explain about synchronous and asynchronous mode of operation of optical network

Part - A.

1) What are the three blocks of ~~the~~ public tele communication network?

→ long haul

→ Metropolitan

→ Access network.



# Asynchronous Transfer mode (ATM)

A wide area-network (WAN) technology, ATM is a transfer mode for switching and transmission that efficiently and flexibly organizes information into cells; it is asynchronous in the sense that resource of cells depends on the required or instantaneous bit rate.

## ATM cell format:

As information is transmitted in ATM in the form of fixed-size units called cells. As known already each cell is 53 bytes which consists of 5 bytes header and 48 bytes payload.

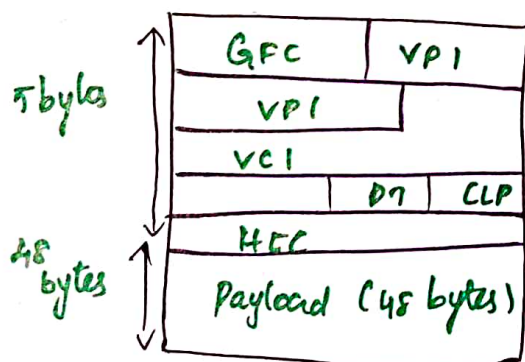
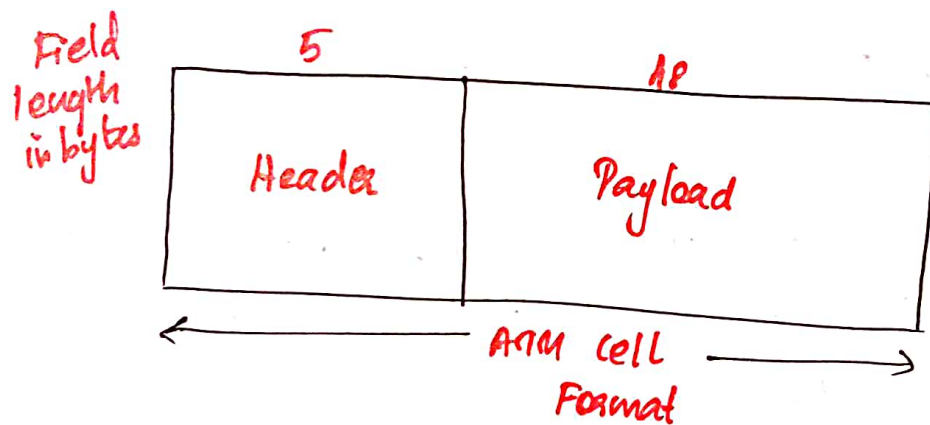

fig. UNI cell format

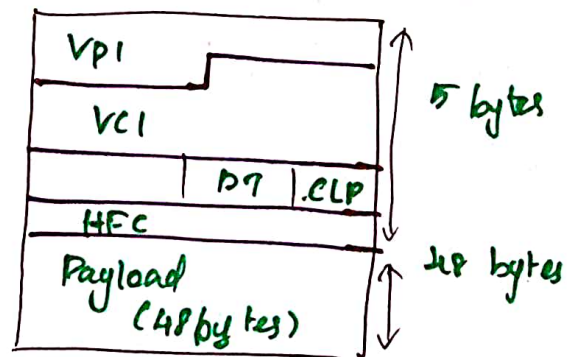

fig NNI cell format



## Two cell format:

### 1. UNI Header:

This is used within private networks of ATM for communication between ATM endpoints and ATM switches. It includes the generic flow control (GFC) field.

### 2. NNI Header:

This is used for communication between ATM switches, and it does not include the generic flow control (GFC) instead it includes a virtual path identifier (VPI) which occupies the first 12 bits.

## Working of ATM:

→ ATM Standard uses two types of connections. Virtual path connections (VPC) which consists of VCs bundled together which is basic unit carrying a single stream of cells from user to user.

→ A virtual path can be created end to end across an ATM network, as it does not route the cells to a particular virtual circuit. In case, all cells belonging to a particular virtual path are routed the same way through the ATM network, thus helping in faster recovery.

→ Switches connected to subscribers use both VPIs and VCI to switch cells which are virtual path



and Virtual Connection Switches that can have different virtual channel connections between them, serving the purpose of creating a virtual trunk between the switches which can be handled as a single entity. Its basic operation is straight-forward by looking up the connection value in the local translation table determining outgoing port of connection and new VPI/VCI value of connection on that link.

### ATM Layers:

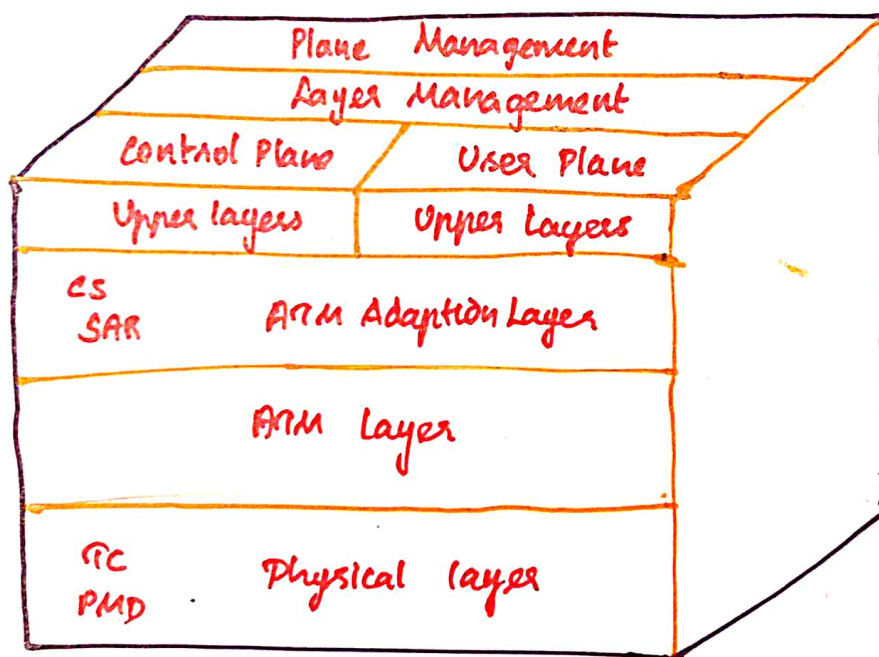

#### 1. ATM Adaption layer (AAL):

It is meant for isolating higher-layer protocols from details of ATM processes and prepares for conversion of user data into cells and segments it into 48-byte cell payloads.



## 2. Physical Layer:

- It converts cells into a bitstream
- It controls the transmission and receipt of bits
- It can track the ATM cells boundaries
- Look for the packaging of cells into the appropriate type of frames.

## 3. ATM Layer:

It handles transmission, switching, congestion control, cell header processing, sequential delivery etc. and is responsible for sharing virtual circuits over physical link known as cell multiplexing and passing cells through an ATM network known as cell relay making use of VPI and VCI information in the cell header.

## ATM Applications:

### 1. ATM WANs:

It can be used as a WAN to send cells over long distances, a router serving as an end-point between ATM network and other network, which has two stacks of the protocol.



## 2. Frame relay backbone :

Frame relay services are used as a networking infrastructure for a range of data services and enabling frame-relay ATM service to interconnecting services.

## 3. Residential broadcast networks

ATM is by choice provides the networking infrastructure for the establishment of residential broadcast services in the search of highly scalable solutions.

## Frequently asked Question:

2 mark

1. What are the applications of ATM?

The applications are,

1. ATM WAN

2. Frame relay backbone

3. Residential broadcast networks.

2. What are the types of cell format?

There are two cell format,

1. UNI Header

2. NNI Header.



# Internet Protocol

The internet Protocol (IP) is a set of requirements for addressing and routing data on the Internet. IP can be used with several transport protocols, including TCP and UDP. It allows connected devices to communicate with each other, regardless of any differences in their internet Processes Structure or design. Network Protocols are the reason you can easily of the communicate with people all over the world, and thus play a critical role in modern digital communications. The internet Protocol Provides the basic unit data transfer, provide addressing routing and fragmentation. The internet Protocol resides at the network layer and sends and receives blocks of data called datagrams. Received from upper layer software. IP feeds these datagrams to its attached data link layer which sends and receives these data gram as a series of packets. A datagram is analogous to a first class letter sent in a Post. In general, it will reach its destination but there is no formal acknowledgement



that the letter was received like there would be with either registered or certified mail. IP utilizes a 'best effort' or 'connectionless' delivery service between source and destination addresses. It is connectionless because there was no formal session established between the source and destination before the data was sent. Packets can be lost as they traverse the network or worse thereby corrupting data grams. It is not the responsibility of IP to guarantee the delivery of messages therefore IP is frequently termed an unreliable delivery service

Service

Diagram: unreliable connectionless

Reliable connection oriented

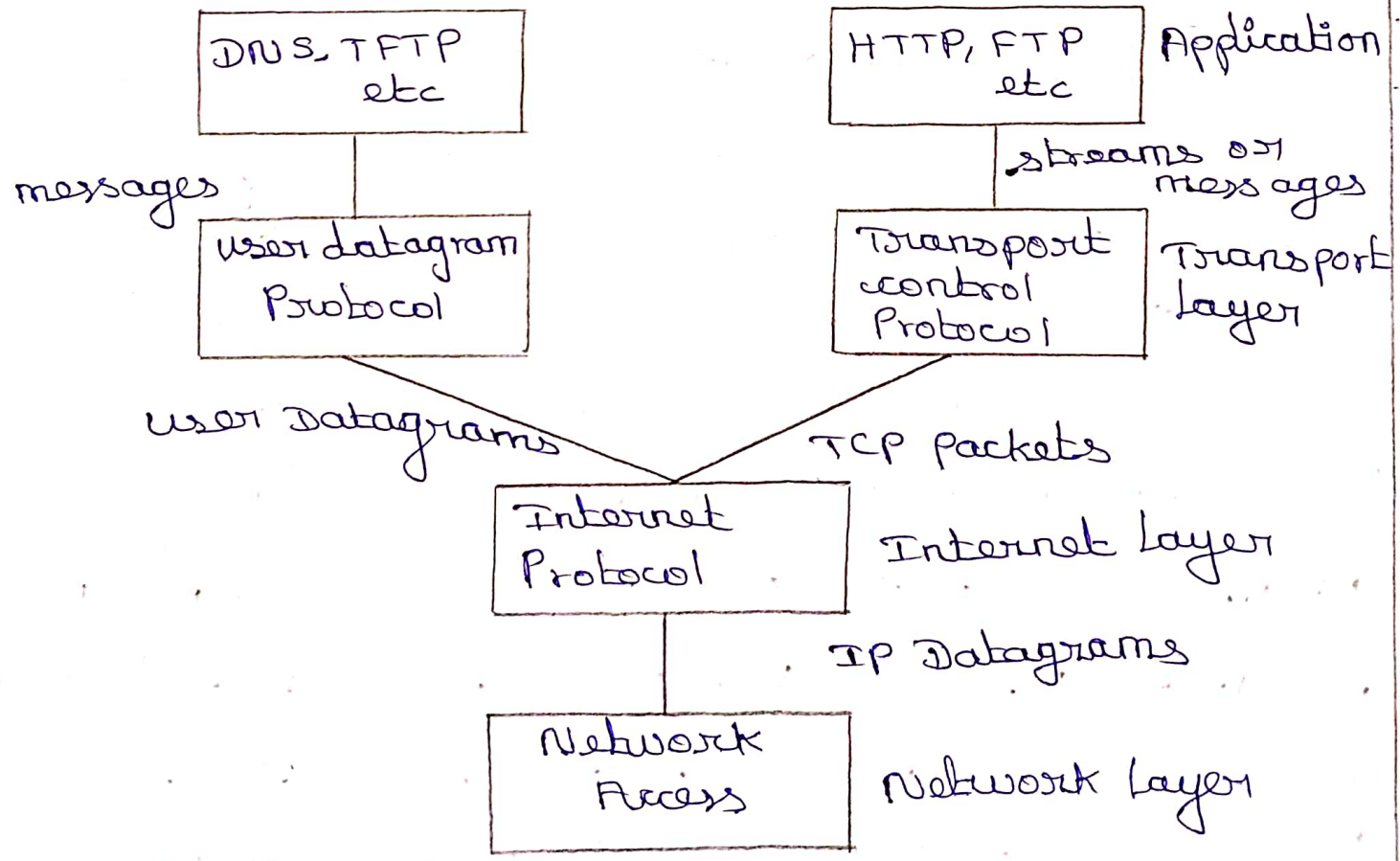



The Internet Protocol layer in TCP/IP Protocol Stack is the first layer that introduces virtual network abstraction. The basic unit of data exchange in the IP layer is the Internet datagram. The format of an IP datagram and a short description of most important fields

### Diagram

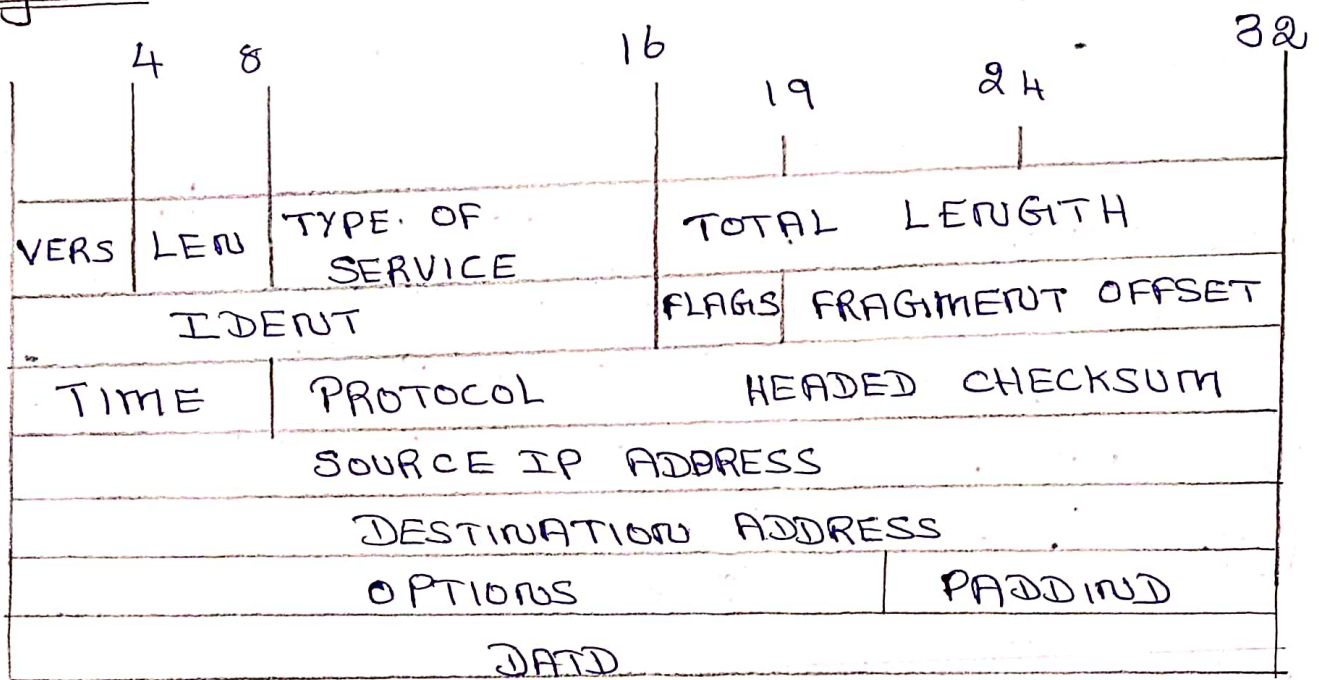

Internet Protocol is connectionless and unreliable protocol. It ensures no guarantee of successfully transmission of data.

In order to make it reliable, it must be paired with reliable protocol such as TCP at the transport layer.

Internet Protocol transmits the data in form of a datagram.







## Advantages:

- i) connectivity
- ii) Scalability
- iii) Flexibility
- iv) Reliability
- v) security

## Disadvantages:

- i) Security risks
- ii) Dependence on connectivity
- iii) Limited scalability.
- iv) Lack of privacy
- v) Technical complexity

## connectivity:

Internet Protocol enables devices to communicate with each other across the world. This means that people from different parts of the world can share information and work together

## Seamlessly

## Scalability:

Internet Protocol is designed to handle a large number of devices and networks. This means that as the number of devices and networks on Internet grows, Internet Protocol can easily accommodate

## Flexibility:

Internet Protocol is a flexible protocol that allows for the creation of customized networks. This means that organizations can create their own private networks



## Security risks:

Internet Protocol is vulnerable to attacks such as hacking, phishing and denial of service, which can result in data breaches loss of personal information, and financial losses.

## Dependence on connectivity:

Internet Protocol relies heavily on network connectivity and any disruptions in the network can result in communication and connectivity rendering it unstable.

## Limited scalability:

Internet Protocol has limitations in the number of devices it can connect and as the number of devices increases the IP addresses may run out resulting in connectivity issues.

## Uses

The Internet Protocol is responsible for addressing host interfaces encapsulating data into datagrams (including fragmentation and reassembly) and Routing datagrams from a source host interface to a destination host interface across one or more IP networks.

The HTTP is the most helpful Protocol for the internet in all web addresses.

Transmission computers to connect. Simple



mail Transfer Protocol is an internet communication Protocol for sending electronic mail

Application

Data
------

Transport

TCP/UDP Header	TCP/ UDP DATA
-------------------	---------------------

Internet

IP Header	IP Data
--------------	---------

Packets can take different routes to the same place. just as a group of People driving to an agreed-upon destination can take different roads to get there.

Working:

IP connects with host through interfaces. It converts data into datagrams, which are the header info consisting of source / destination and metadata and the Payload which is the data itself. IP encapsulates the data nesting it into packets.



# Wavelength Routing Networks : Routing and Wavelength Assignment

## Wavelength Routed Networks :

> Two problems arise in broadcast and select networks

1. More wavelengths are needed as the number of nodes in the network grows

2. Splitting losses is high

> Wavelength routed networks overcome these limitations through wavelength reuse, wavelength conversion and optical switching

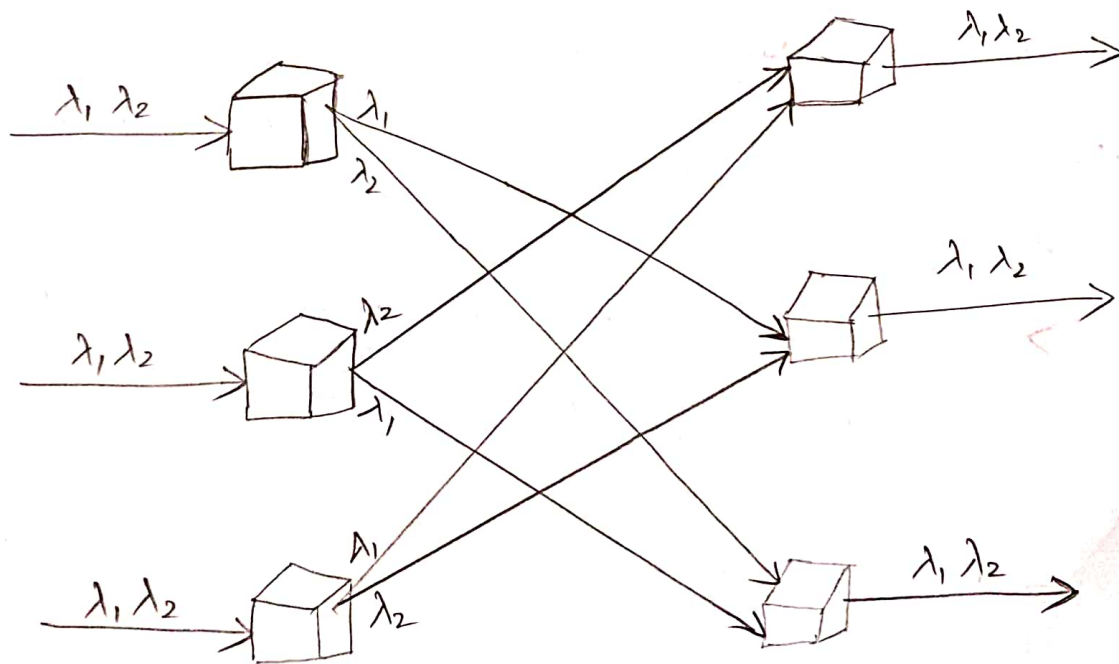

Base node of a wavelength routing network.

wherein wavelengths of the same wavelengths are used repeatedly



# Wavelength Routing and Assignment

- For successful data transmission
  - > A route has to be found
  - > An appropriate wavelength has to be assigned between transmitter and receiver.
  - > This is called the routing and wavelength assignment (RWA)
- There are 2 problems in the RWA
  - > Wavelength Continuity Constraint
  - > Distinct wavelength Constraint

## Wavelength Continuity Constraint

- When the routing nodes are not capable for wavelength conversion
  - > Then the light path must use the same wavelength in all the optical segments it uses.
  - > In the absence of a free wavelength along the entire route, the connection can not be established and it is blocked



- When wavelength conversion is present

- > The only limiting factor is the bandwidth of every link.

- > In such networks, a connection is blocked only when no wavelength is available at some segment of an optical path

### Distinct Wavelength Constraint

- If all light paths using the same link (fiber), then the light path should be allocated to different wavelengths.

- RWA problem can be classified into two traffic assumptions :

- Static RWA problem

- > Static Light path Establishment (SLE)

- > traffic requirements are known in advance

- Dynamic RWA

- > Dynamic Light path Establishment (DLE)

- > The order of light path requests arrive randomly.



## Routing Assignment :

### • Fixed Routing

> A single fixed route is predetermined for each source - destination pair

### • Adaptive Routing

> Alternate - path Routing

> Relies on a set of predetermined fixed routes between a source node and a destination node

> When a connection request arrives, a single route is chosen from the set of predetermined routes, and a light path is established on this route

> The criteria for route selection are typically based on either path length or path congestion

## Wavelength Assignment :

• A light path is required to be established before data is transferred between two communicating nodes.

• No two light paths can share a common link using the same wavelength, known as



- When wavelength conversion is present

- > The only limiting factor is the bandwidth of every link.

- > In such networks, a connection is blocked only when no wavelength is available at some segment of an optical path

### Distinct Wavelength Constraint

- If all light paths using the same link (fiber), then the light path should be allocated to different wavelengths.

- RWA problem can be classified into two traffic assumptions :

- Static RWA problem

- > Static Light path Establishment (SLE)

- > traffic requirements are known in advance

- Dynamic RWA

- > Dynamic Light path Establishment (DLE)

- > The order of light path requests arrive randomly.



## Wavelength Continuity Constraint

- Blocking probability increases
- A possible alternative to reduce blocking probability is the use of opto-electronic wavelength converters.
- But these converters add substantially to the cost of the network.
- So we need some form of network control or signalling mechanism if we do not use wavelength converters

## Advantages of Wavelength routing Networks:

> Wavelength routing networks offer higher data rates, reduced latency, and increased capacity due to the use of optical signals, making them more efficient for data transmission.

### Detail question (expected):

1. How does wavelength Assignment work in optical networks, and what are the strategies for optimizing the allocation of wavelength within a network?



## Expected questions:

1. What is the primary function of wavelength Routing in optical networks?

The primary function of wavelength Routing is to establish the path for optical signals based on the wavelength (colour) of light

2. How does wavelength clashing affect network performance, and how it can be mitigated?

Wavelength clashing occurs when two or more signals with the same wavelength collide in the network, causing interference. It can be mitigated by using wavelength conversion or intelligent routing algorithms to avoid clashes

3. How does Routing and wavelength Assignment (RWA) differ from traditional IP routing in data networks?

RWA focuses on selecting the optical path and assigning wavelength for data transmission, whereas IP routing is concerned with packet forwarding in data networks



**Optical switching :** Optical circuit switched Network

- In optical circuit switching, the network is configured to establish a circuit, from an entry to an exit node, by adjusting the optical cross connects circuits in a manner that the data signal can travel in an All optical manner

- When ocs is based on light path, it is called as optical wavelength switching.

- Optical circuit switching is an optical networking technology. Network is configured to establish a circuit, from an entry node to an exit node. A circuit is created by adjusting the cross connects so that data can travel from entry node to exit node in a core network. Ideally, the packets that enter the network should be transmitted from the ingress to egress point in optical form. The technology from can read the header of data in optical form is not yet introduced so to forward data or to take routing decision data should be converted into



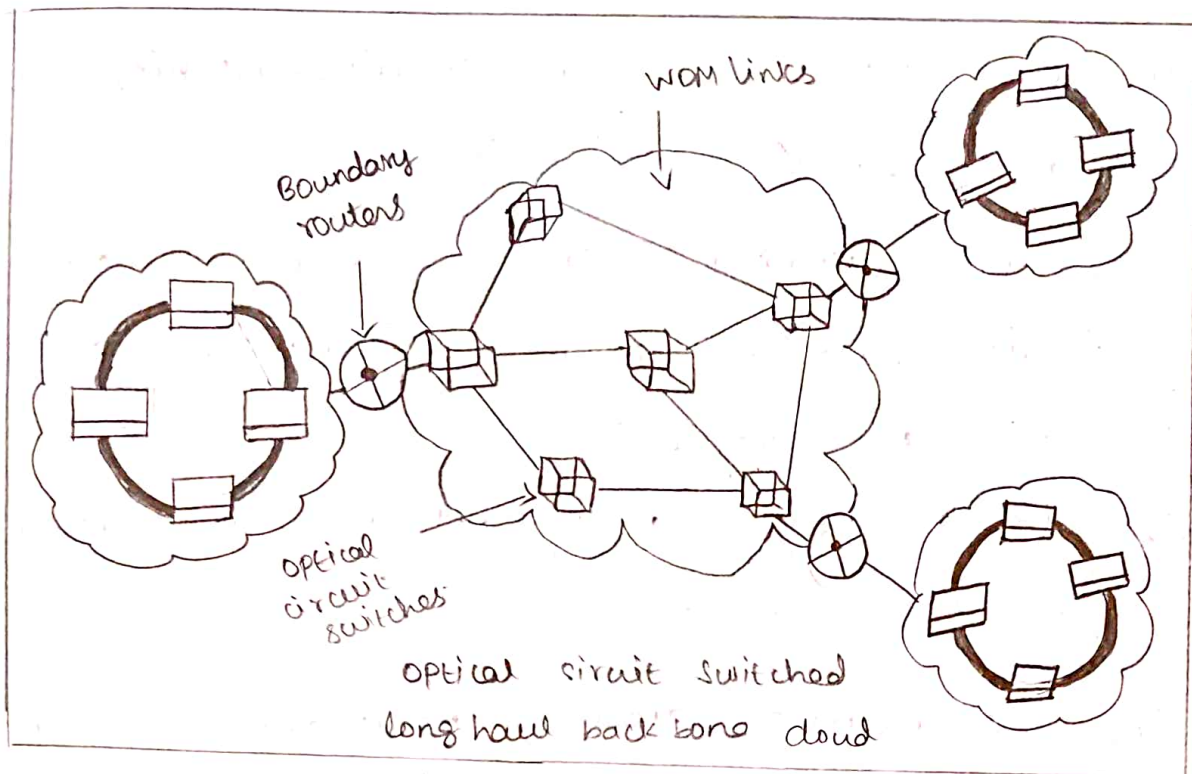

Optical circuit switching network

The OCS has coarse switching granularity and thus resulting in high packet completion time and low bandwidth utilization, but it benefits the low implementation complexity that is easier to be deployed. As a comparison the OPS, benefiting from the fine switching granularity, can best complete the traffic flow with high bandwidth utilization. However, the implementation complexity and high control overhead limits its practical application.



## Questions

1. Explain the concept of optical circuit-switching and how it differs from packet-switching.
2. What are the advantages and disadvantages of optical circuit switched networks compared to other network technologies?
3. Describe the basic components of an optical circuit switched network.
4. How does wavelength division multiplexing work in optical networks, and what role does it play in circuit switching?
5. Discuss the challenges and limitations of implementing optical circuit switched network.

Two marks

1. What is an optical circuit switched network?  
It is a type of network that establishes dedicated optical paths for data transmission.
2. What are the key components of an optical circuit switched network?  
Optical switches, optical cross-connects, physical fiber-optic infrastructure



## Optical Packet

## Switched Networks

Defn.:

A switch that enables signals in optical fibers or integrated optical circuits [IOCs] to be selectively from one circuits to another.

Optical Networks types:

- \* SDH/SONET System
- \* OEO (opaque optical Network)
- \* Optical Networks with varying degree of transparency.
- \* All-optical networks.

Outline :

- \* Introduction to optical packet switching
- \* Synchronization
- \* Header extraction
- \* Contention resolution & avoidance
  - wavelength conversion
  - optical buffering
  - Deflection routing



## optical packet switching (OPS)

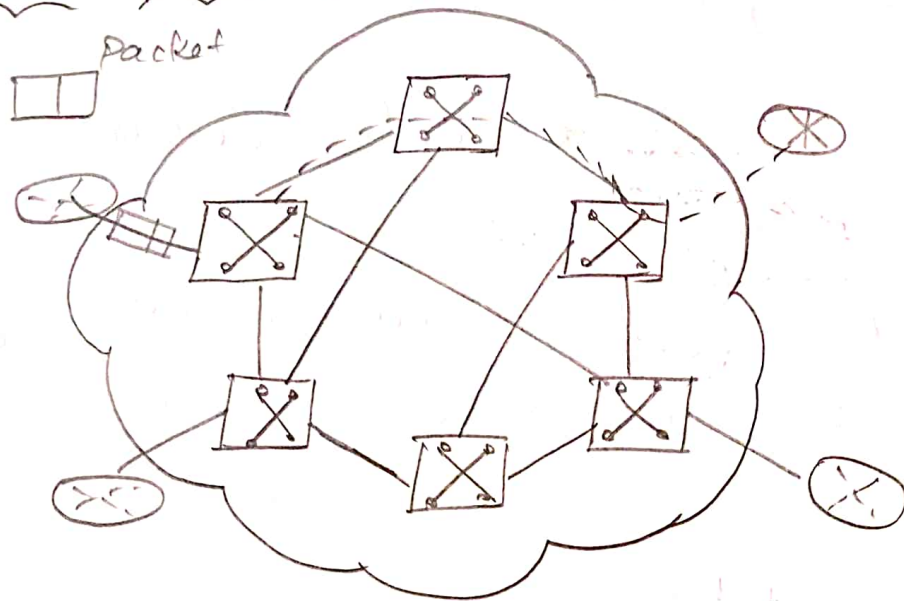

Packet consists of payload and header

Packets switched directly in the optical domain

Higher degrees of multiplexing.

### Challenges for OPS

\* Fast switching time in order of ns

\* Synchronization

\* Header processing

- Lack of optical processing

\* Contention Resolution

- Switching times

- Lack of optical RAM storage.



# Switch Architecture

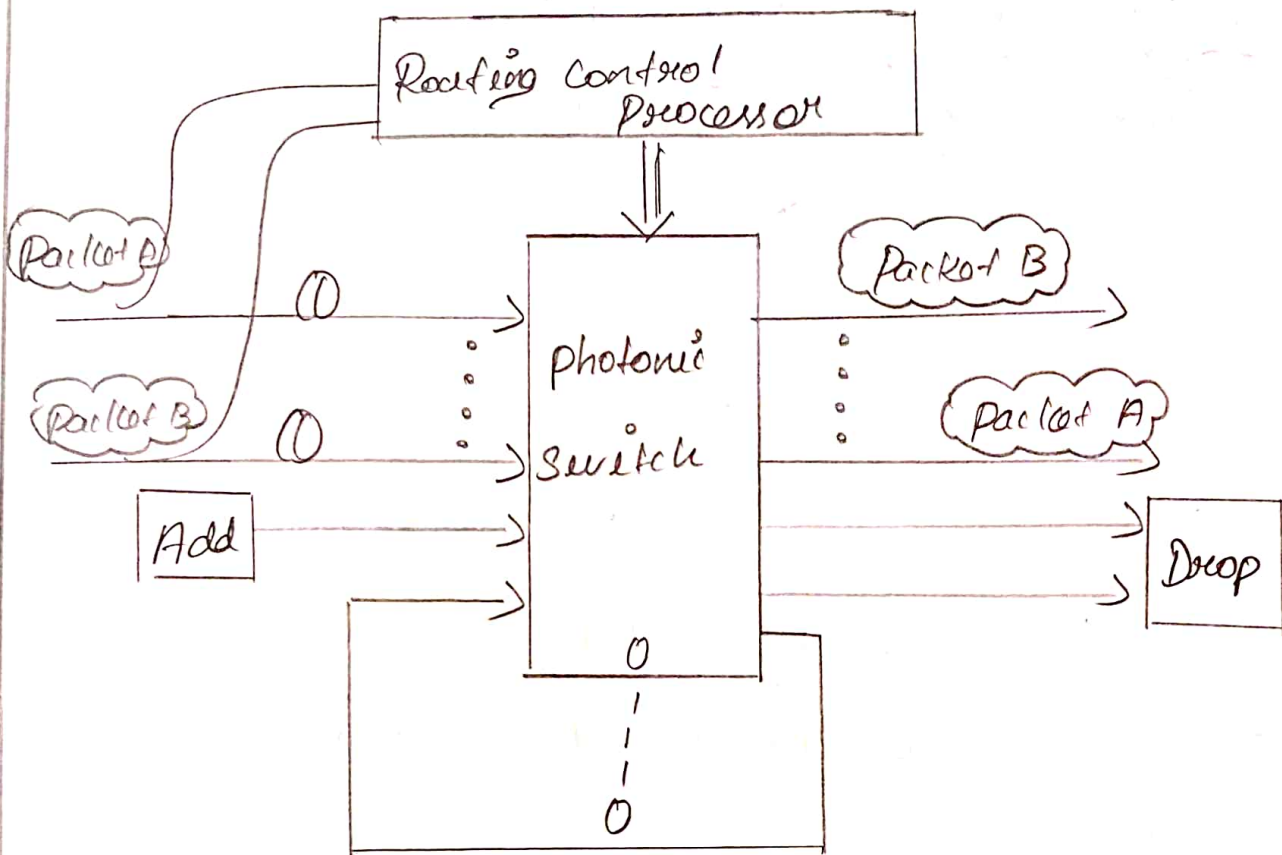

## Functions

- \* Packet arrives to input
- \* Header extracted
- \* packet switched to output

## Optical packet switched Networks

### Time-slotted synchronous

- o Fixed or variable size packets
- o Packet length integer multiple of slot size
- o Require synchronization



- Higher throughput
- Difficult to implement

### Unslotted / asynchronous

- Fixed or variable-size packets
- No synchronization
- Less expensive

### Application :

Many of today's applications can be categorized into

- Latency-critical application
- Small-to medium-size file transfers with low-latency requirements

Ex:

Broadcast television, interactive video, conferencing, security video monitoring, interactive games, telemedicine and telecommuting.

- Throughput-critical applications
- Large-size file transfers require much b.w with relaxed latency constraints.

Ex: videos on demand (VoD), video & still-image email attachment, backup of files downloading.



## Generic packet format

consists,

- Header
- payload
- additional guard bands before & after payload.

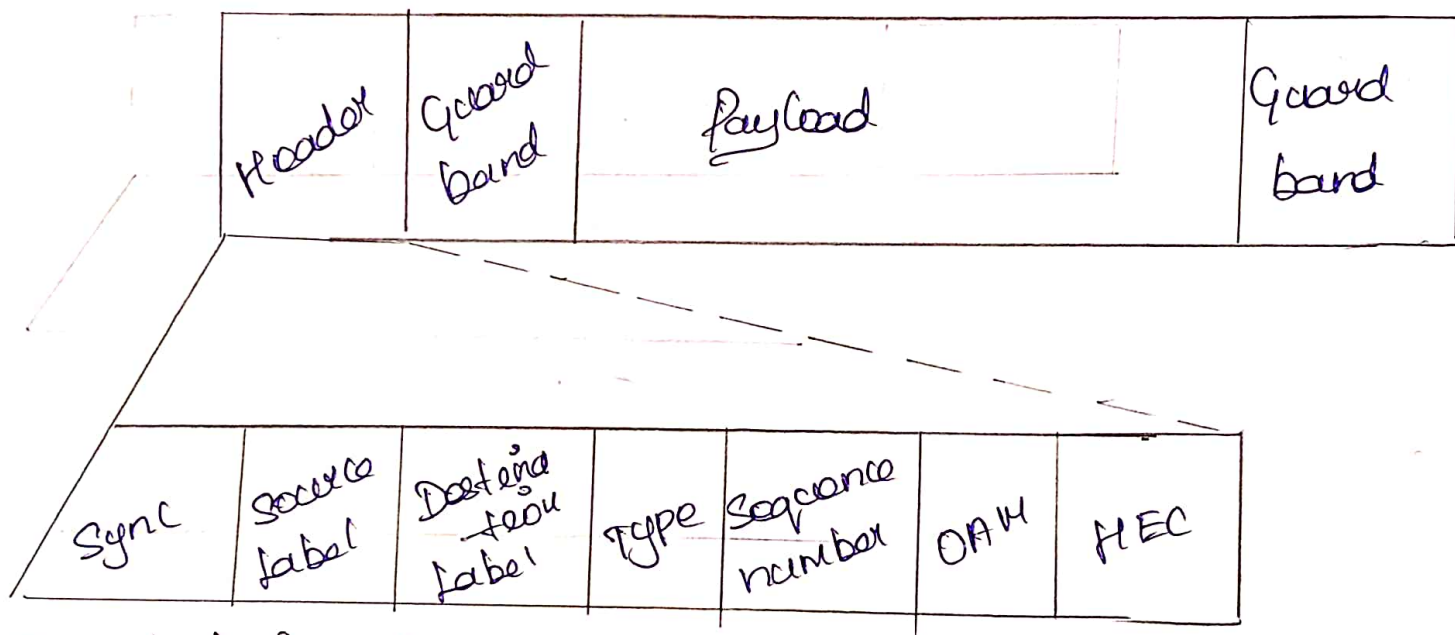

Two techniques:

### • Optical Circuit Switching:

- \* Bandwidth inefficient for bursty data
- \* Frequency long circuit setup
- \* Waste bandwidth during off (low-traffic

periods



## Optical packet switch

- \* packet contains a header and the payload
- \* Each node needs to buffer, process the header, and send it to the next switch.



# Multi protocol Label Switching

\* MPLS is an IP Packet routing technique that routes IP Packet through path via Label instead of looking at complex routing tables of router.

\* This feature help in increasing the delivery rate of IP Packets.

\* MPLS uses Layer 3 Services i.e., Internet protocol and uses router as forwarding device.

\* The traffic of different customer is separated from each other because MPLS works somewhat like VPN.

\* It does not work like regular VPN that encrypts the data but its ensure packet from one customer cannot be received by another customer.

\* An MPLS header is added to packet from that lies between Layer 2 and 3. Hence it also considers to be Layer 2.5 protocol.



# MPLS Header [32 bit long]

It is divided into **FOUR** parts

1) Label

\* The field is 20 bit long and it can take value between  $0$  &  $2^{20} - 1$ .

2) Exp

\* They are the 3 bit long and used for

QoS

3) Bottom of Stack(s)

\* It is of size 1 bit. MPLS labels are stacked one over other.

\* If there is only one label remained in MPLS header, then its value is 1 otherwise 0

4) Time to live (TTL)

\* It is a eight bit long

\* Its value is decreased by one at each hop to prevent packet to get stuck in network



Terms	Description
Power Edge (PE) Router	Router at edge of MPLS network that add or remove label from IP Packet
Customer Edge (CE) Router	Router at edge of customer network that send or receive IP packet from PE
Label Switch Router (LSR)	Router used in MPLS network that can understand label
Ingress LSR	LSR router that receive IP packet from CE Router and MPLS header
Intermediate LSR	LSR router that swap label in MPLS header and assigned for forwarding labeled IP Packet
Egress LSR	LSR router that send IP packet to CE router and remove MPLS header
Push, Pop and Swap.	Action of addition, removal and swapping of labels by LSR respectively.



## Forwarding in MPLS:

\* LSR Receive IP Packet CE and add an MPLS header in between layer 3 and layer 2 means it encapsulates the link layer

i.e; layer 2 frames

\* This feature allows LSRs to support receiving packets containing frames from different protocols like frame Relay, Metro Ethernet etc, that's why it is called Multi protocol

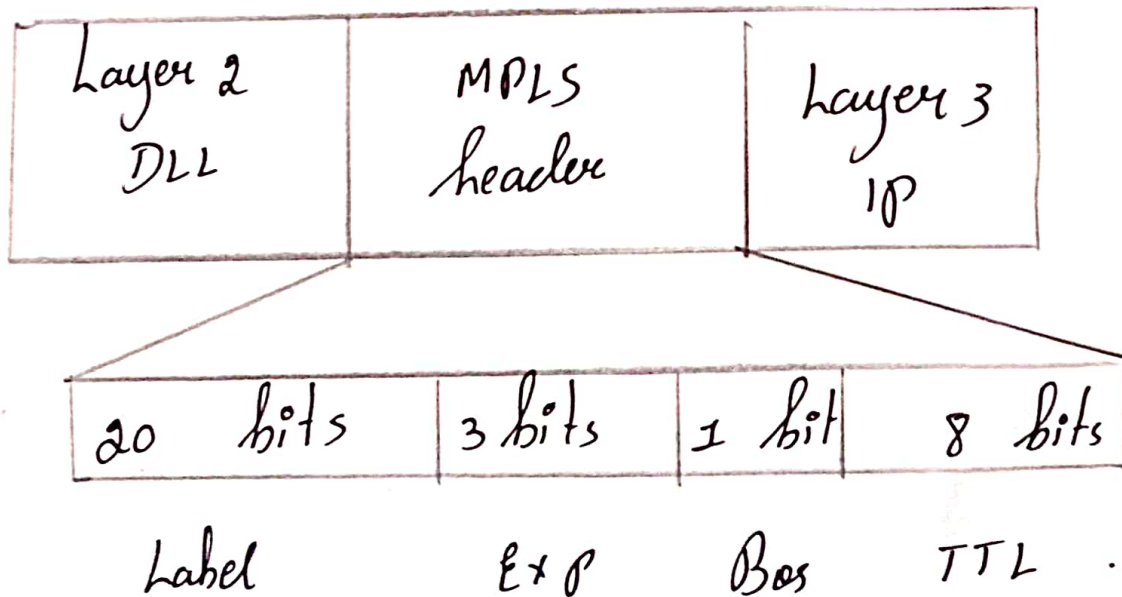



# Optical Burst Switching Networks.

## Optical switching Techniques.

### Optical circuit switching

- Bandwidth inefficient for bursty data
- frequently long circuit setup.
- Low traffic periods.

### Optical Packet switch.

- ⇒ A packet contains a header & the payload.
- each node needs to buffer, process the header, & send it to the next switch.

### OBS.

- OBS combines benefits of ocs and ops
- OBS is an attempt at a new synthesis of optical & electronic technologies.
- OBS lies b/w OPS & WRN.
- In OBS, data is transmitted in variable size packets called, Burst.
- A burst is switched to next node before its last bit arrives which will reduce offset time.



- No store and forward is required.
- It provides strong separation b/w control & data plane.
- It will reduce the problem of bursty traffic.

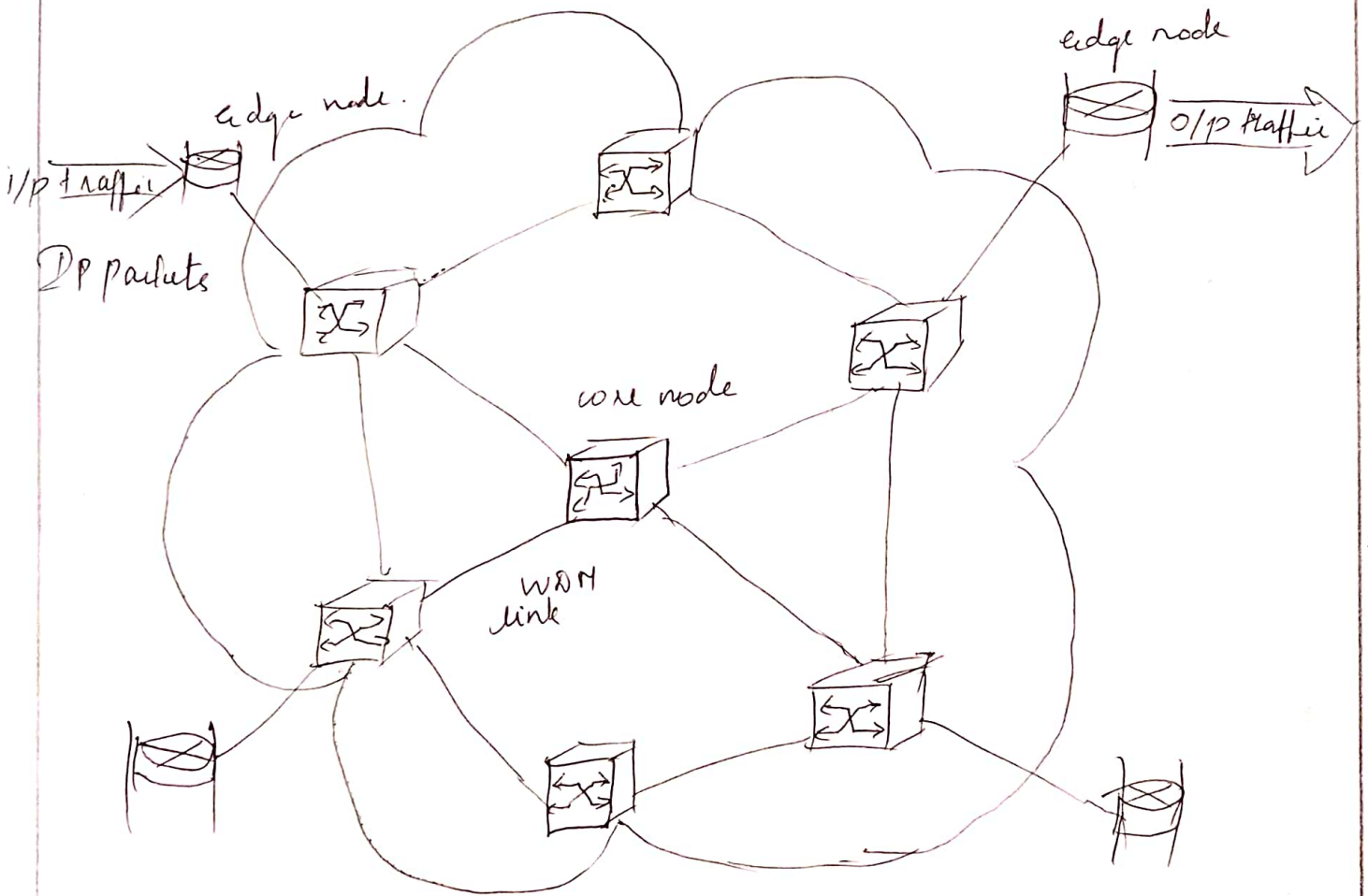

optical switching  
paradigms

BitW  
utilization

latency

optical  
Buffer

proc./sync.  
overhead.

circuit

Low

High

Not  
required

Low

Packet full

high

low

required

high

OBS

high

low

not  
required

low.



## OSI Network edge

Network edge OSI users perform the following four functions

- \* Guest assembly
- \* Signaling
- \* Routing & wavelength assignment
- \* Computation of offset time for control Packet

## Data Transmission in OSI

- Data is transported in variable sized units called burst.
- When burst is ready, reservation request is sent to the next resource.
- Control & data signals are sent on diff channels.
- There are two protocols for data Transmission in OSI namely TET & TIT



# OBS Fundamentals

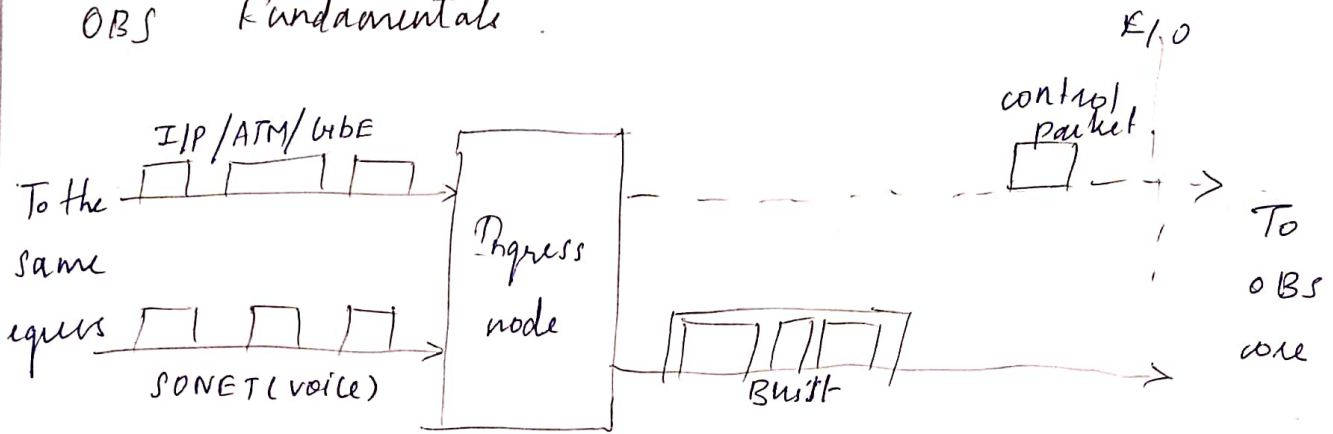

a) Burst Assembly

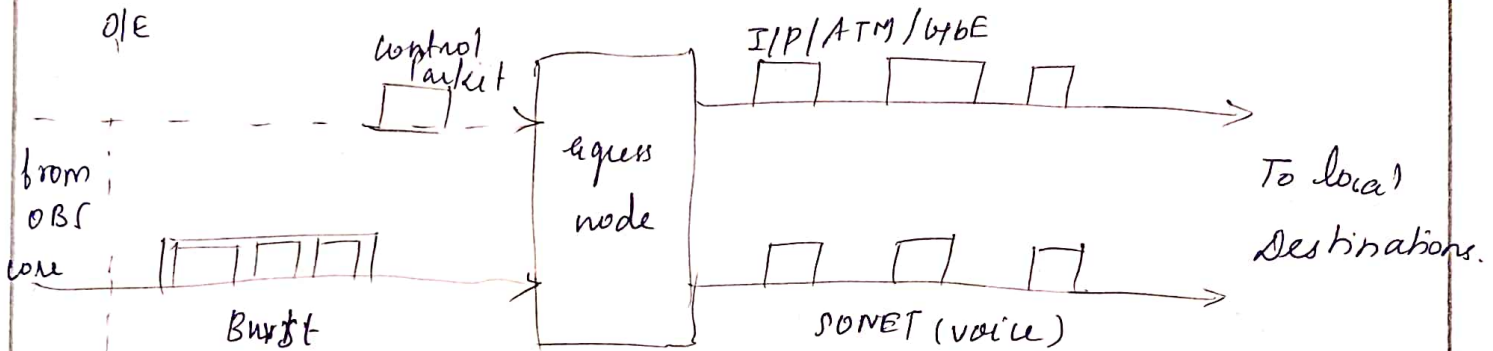

b) Burst Disassembly

- \* In an OBS n/w, various types of client data are aggregated at ingress & transmitted as data bursts which later will be disassembled at egress node.
- \* The process of burst assembly is called as the burstification.



## Fast enough Time (JET)

JET is a special protocol for reservation of resources for burst.

Basic ideas .

→ Each control packet carries the information like

→ offset time & burst length.

→ The offset time is chosen so that no optical buffering or delay is required at the intermediate nodes.

## Just in Time (JIT)

→ Connection establishment

→ Connection tear down.

→ Connection failure due to request rejection

→ Connection failure due to data loss.



## Advantages & disadvantages.

### Advantages:

- \* More efficient bandwidth utilization
- \* Remove throughput limitation
- \* Guard band b/w burst and header
- \* Reduce processing requirements
- \* Energy consumption.

### Disadvantages:

- \* Limited / No QoS
- \* Less processing speed
- \* Noise problem.



# Optical Network Deployment.

Optical networks are designed with various optical components, including fiber optic cables, receivers and transmitters and optical switches. Using optical networking, you can transmit information at light speed, it's perfect for low-latency connections and covering longer distances.

Optical network: a modern, complex dense wavelength division multiplexed backbone network with add/drop channels also interconnecting metropolitan, access, local area and enterprise network.

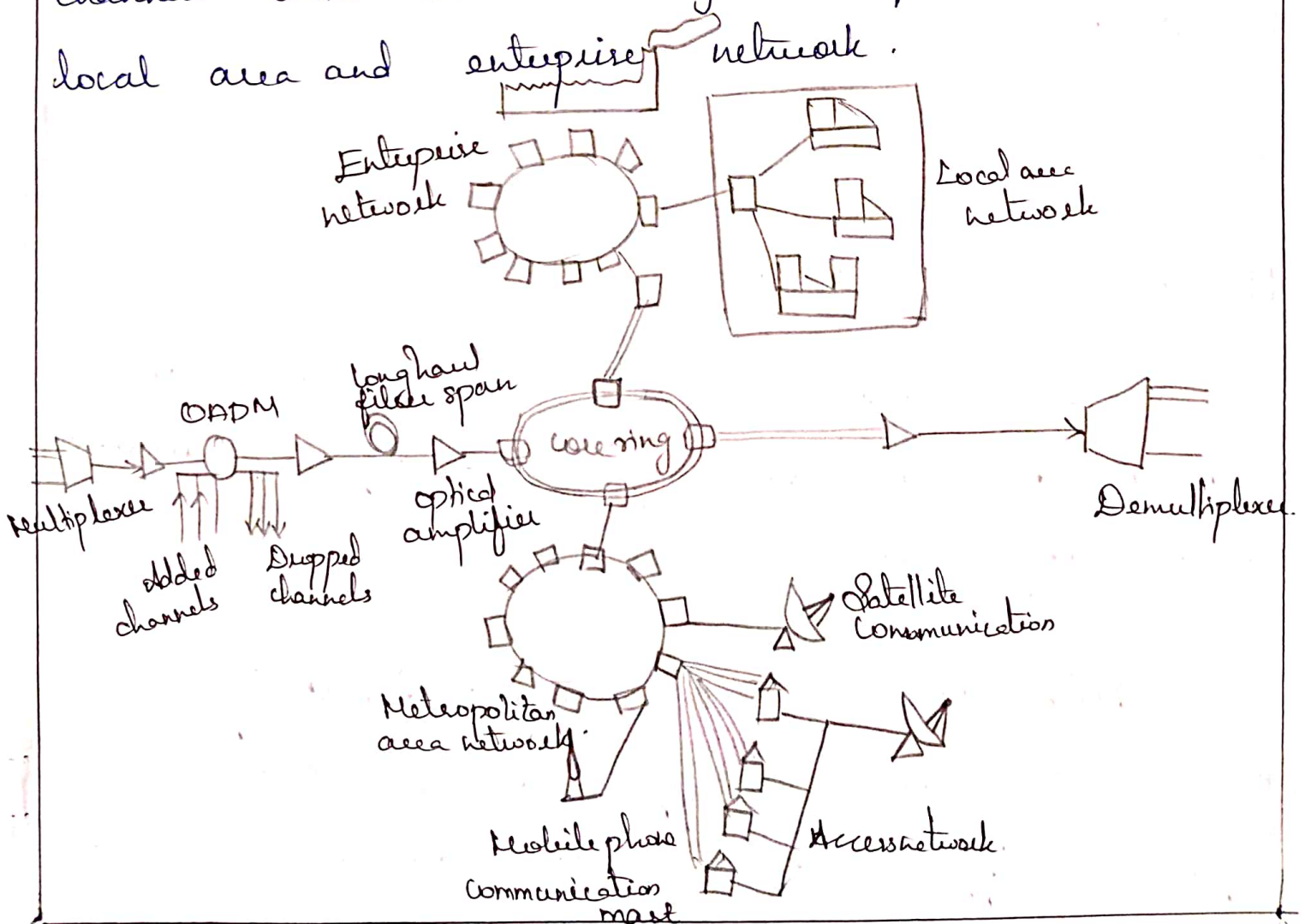



## Long Haul networks :

A long haul network as the name implies is a network connecting several regional or national networks together. These networks are also referred to as core or backbone networks and they also interconnect other long haul networks to extend global interconnectivity between national domains.

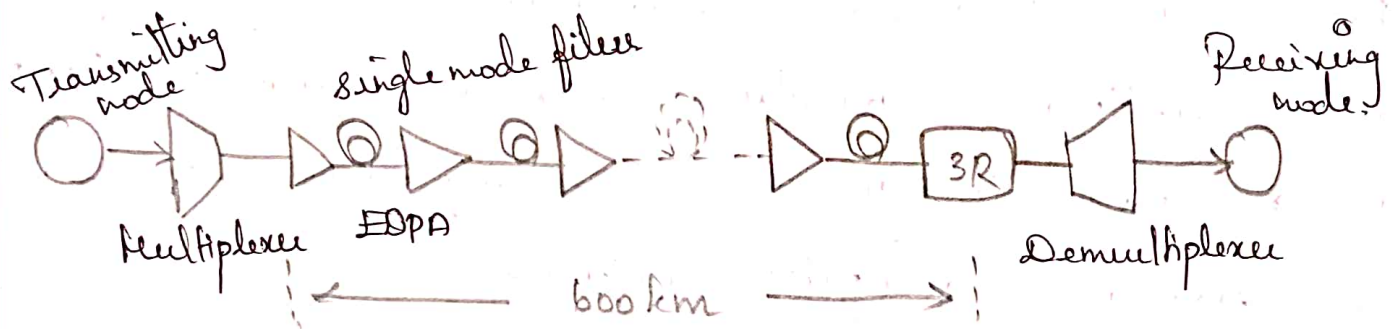

## Metropolitan area networks:

The metropolitan area networks or metro networks provide the regional interface interconnecting with local long haul networks.

Metro networks are subject to specific requirements and traffic demands that are quite different from long haul or access networks.



## Access Networks:

The access network is an element of a public telecommunications network that connects access nodes to either individual users or MANs.

An access network is a type of network which physically connects an end system to the immediate router on a path from the end system to any other distant end system.

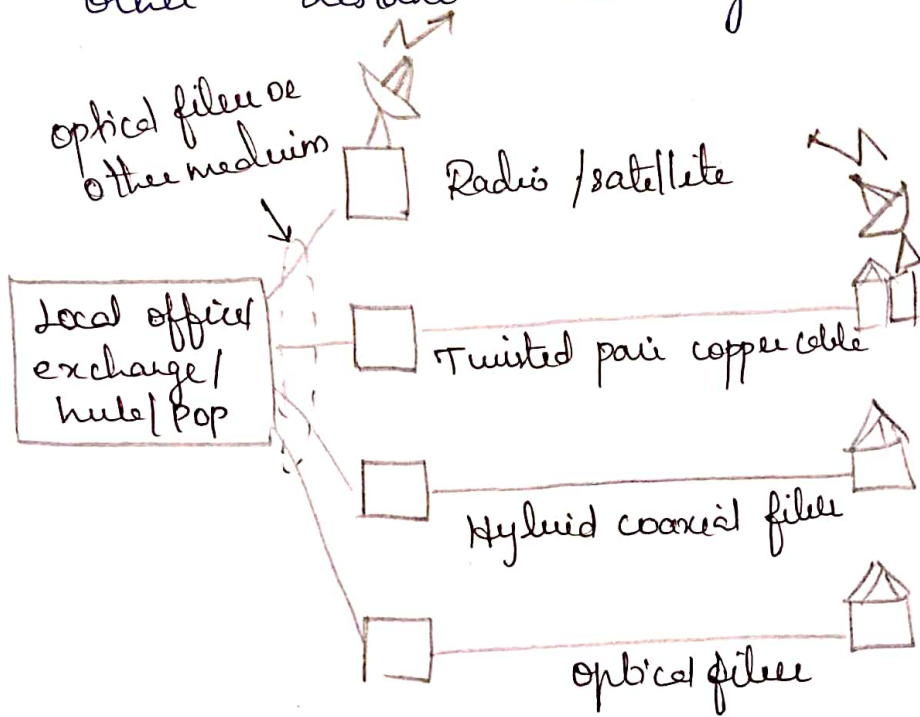

## Local area network:

A local area network is a collection of devices connected together in one physical location such as a building, office or home.

A LAN can be small or large, ranging from a home network with one user to an



enterprise network with thousands of users and devices is an office or school.   
 feeder Distributor.

